

MIRAN 205B Series SapphRe

Instruction Manual

Portable Ambient Air Analyzers

Part Number BK3538

26Jun2015

© 2007 Thermo Fisher Scientific Inc. All rights reserved.

Specifications, terms and pricing are subject to change. Not all products are available in all countries. Please consult your local sales representative for details.

Thermo Fisher Scientific
Air Quality Instruments
27 Forge Parkway
Franklin, MA 02038
1-508-520-0430
www.thermo.com/aqi

WEEE Compliance

This product is required to comply with the European Union's Waste Electrical & Electronic Equipment (WEEE) Directive 2002/96/EC. It is marked with the following symbol:



Thermo Fisher Scientific has contracted with one or more recycling/disposal companies in each EU Member State, and this product should be disposed of or recycled through them. Further information on Thermo Fisher Scientific's compliance with these Directives, the recyclers in your country, and information on Thermo Fisher Scientific products which may assist the detection of substances subject to the RoHS Directive are available at: www.thermo.com/WEEERoHS.

CONTENTS

1. Introduction.....	1-1
General Description.....	1-1
2. Specifications	2-1
3. Instrument Preparation.....	3-1
Unpacking	3-1
Identification	3-3
Wand and Filters	3-4
Adjusting Shoulder Strap	3-4
Charger/Power Supply	3-5
Analyzer Output Connections	3-8
4. Operation.....	4-1
Controls and Display	4-1
Passcode Access	4-2
Control Menu	4-2
Entering Numeric Characters	4-3
Making Menu Selections.....	4-3
Menu Structure	4-3
Startup Procedure	4-4
Using the Search Feature.....	4-11
Information Screens	4-12
Error Screens	4-13
Changing the Pathlength	4-16
Analog Output	4-17
Instrument Orientation	4-17
5. Analyze/Start.....	5-1
To Zero the Analyzer	5-1
To Begin Analysis	5-4
Log.....	5-5
Zero	5-5
Location Name	5-5
Error Fault Messages.....	5-7
6. Change Gas.....	6-1
Spectrum Scan	6-4

7. Configuration and Setup	7-1
Calibration	7-3
Preferences	7-3
Gas Unit.....	7-5
Clock	7-6
Analysis	7-7
Analysis Setup page 1	7-8
Analysis Setup Page 2	7-17
Analysis Setup Page 3	7-19
Analysis Setup Page 4	7-21
Application View and Edit	7-25
8. Site Info	8-1
Sites	8-1
Locations	8-2
Sites and Locations Summary	8-5
9. Report/Data Transfer	9-1
Select Site	9-1
Print Menu	9-2
Data Transfer	9-3
Memory Clear.....	9-5
Hyperterminal.....	9-5
10. Maintenance and Service	10-1
Zero Gas Filter.....	10-1
Particulate Filter	10-1
Battery Pack	10-1
Care of Optics.....	10-2
Service Locations	10-3
11. Firmware Update	11-1
Introduction	11-1
Procedure.....	11-2
12. User Performance Verification	12-1
Introduction	12-1
Procedure.....	12-1

13. Infrared Spectroscopy Tutorial.....	13-1
Overview	13-1
Electromagnetic Energy	13-1
Basic Properties of Waves.....	13-3
Atoms and Molecules in Motion	13-4
Qualitative Analysis: Identifying Compounds	13-7
Quantitative Analysis: Measuring Absorption Levels	13-15
The Beer-Lambert Law	13-16
Infrared Spectroscopy Summary	13-18
How the SapphIRe Analyzer Works	13-19
14. Custom Report Formatting.....	14-1
General	14-1
Obtaining a Custom Report.....	14-1
Header	14-2
Gas Data	14-3
Footer.....	14-4
Report-Entry Fields	14-4
Coding Guide	14-5
Appendix A - Warranty	A-1
Appendix B – Intrinsic Safety	B-1
I/O Configuration vs. Location for Miran SapphIRe M205B	B-1
Appendix C – Scan/Calibration Procedure	C-1
Introduction	C-1
A. Create a Logging Site	C-2
B. Perform a Peak Pick or Full Spectrum Scan.....	C-3
C. Download Data From the Analyzer to a PC	C-5
D. – Analyze the Spectrum.....	C-6
E. – Create a New Single Gas or Multi-Gas Library Application.....	C-6
F. – Calibration.....	C-10
G. – Generate the P-Matrix	C-11
H. – Enter P-MATRIX into the Analyzer and Verify Calibration Accuracy.....	C-13

Appendix D – Humidity Compensation Table	D-1
Appendix E. – MIRAN SapphIRe Field Performance Verification Kit	E-1
General	E-1
Introduction	E-1
Instrument Configuration	E-2
Configuring the Gas Sampling Accessory	E-2
Gas Challenge.....	E-3
Appendix F – Parts and Accessories	F-1
Appendix G. – Using Hyperterminal With the MIRAN SpphIRe Analyzer.....	G-1
Appendix H. – Standare Libraries	H-1

Chapter1

INTRODUCTION

GENERAL DESCRIPTION

The MIRAN SapphIRe family of lightweight portable ambient air analyzers consists of a group of infrared instruments that can monitor ambient air in workplace environments for the purpose of detecting the presence of gases (Figure 1-1). The family includes three models, all of which are available in intrinsically safe versions. Some of the major differences among models are shown in Table 1-1.



Figure 1-1. SapphIRe

Table 1-1. Feature Comparison of Various Models

Feature	SapphIRe Analyzer Model		
	DL	SL	XL
Factory calibrated for number of gases listed	0	50	120
User library of 10 single gas and 10 multi-gas applications	Yes	Yes	Yes
Alternate measurement wavelengths	No	Yes	Yes
Fully upgradable to other models	Yes	Yes	N/A
Temperature/humidity/reference compensation	Yes	Yes	Yes
Field calibration by user	Yes	Yes	Yes

In addition to the features noted in Table 1-1, all instrument models may be configured with two options that must be installed at the factory. These are intrinsic safety certification and spectral scanning using the ThermoMatch™ Spectrum Correlation Software.

Each SapphIRE analyzer contains a single-beam infrared spectrophotometer. A microcontroller automatically controls the analysis, processes the measurement signal, and calculates the absorbance values. Analysis results can be displayed in parts per billion (ppb), parts per million (ppm), percent (%), mg/m^3 , or absorbance units (AU).

Warning: Intrinsically safe models require special actions with respect to the following section. Refer to Appendix B for descriptions of these actions.

A rechargeable internal battery pack provides power for up to four hours of continuous operation. The system includes a separate charger/power supply (Figures 3-5 and 3-6) that allows the analyzer to be powered from an ac supply. It is also used to recharge the battery pack either in an offline mode or while the analyzer is running in normal operating mode.

SapphIRE-DL Analyzer

The SapphIRE-DL Analyzer has the ability to measure any compound having an absorbance in the wavelength region from 7.7 microns to 14.1 microns or any of the available fixed band pass filters, such as carbon monoxide, carbon dioxide, formaldehyde, nitrous oxide, hydrocarbons, water, and reference. The SapphIRE-DL Analyzer provides the ability to perform multicomponent analysis. It can take absorbance measurements of up to 10 wavelengths, and display and log compensated concentrations for up to five individual gases. In addition, its user library can be programmed to store up to 10 single gas applications and up to 10 multi-gas applications.

SapphIRE-SL Analyzer

The SapphIRE-SL Analyzer performs all the functions of the SapphIRE-DL Analyzer. In addition, it has 50 single gas factory calibrations in its standard library, many employing an alternate wavelength (see Appendix H). These calibrations allow the selection of a compound from its standard library of gases. The analyzer then "pulls up" the application information, configures itself to measure the compound of choice, and delivers concentration readings for this compound without performing interference compensation. This avoids interference from other gases by selecting a different measurement wavelength for a given gas instead of going through full multicomponent calibration. This feature is beneficial when two different gases have spectra that both exhibit peaks at some wavelengths but not at others. By selecting a measurement wavelength for the target gas that is not common to any other gas, the interference problem can be avoided.

SapphIRE-XL Analyzer

The SapphIRE-XL Analyzer performs all the functions of the SapphIRE-SL Analyzer, except it has more than 120 single gas factory calibrations in its standard library (see Appendix H).

Chapter 2

SPECIFICATIONS

Thermo Fisher Scientific reserves the right to change/modify specifications without prior notice.

Table 2-1. Standard Specifications

Item	Specification
Measurement Range	See Appendix H for each compound range.
Concentration	Compound Dependent
Absorbance	0.000 to 1.2 Au (practical upper limit)
Measurable Gases	SapphIRe-DL: up to 5 gases in a background of 5 additional gases. Storage for up to 10 single gas and 10 multigas applications. SapphIRe-SL: same as SapphIRe-DL, except factory calibrated for 50 single gases. SapphIRe-XL: same as SapphIRe-SL, except factory calibrated for 120 single gases.
Output	Digital readout of concentration (ppb, ppm, %, mg/m ³) or absorbance units (AU). Also connections for analog output, relay contacts, parallel port (printer) and serial communication (RS232).
Wavelength	Seven fixed bandpass filters and one continuously linear variable filter (7.7 to 14.1 microns). The seven fixed wavelengths are: 1.859 water vapor, 3.333 general hydrocarbons, 3.573 formaldehyde, 4.004 reference, 4.250 carbon dioxide, 4.500 nitrous oxide, and 4.620 carbon monoxide.
Pathlength	Two user-selected settings: 0.5 and 12.5 meters nominal
Battery Pack	Type: Internal, rechargeable, sealed, intrinsically safe NiCd (Nickel-Cadmium) battery pack. Voltage: 7.2 V nominal. Capacity: 5.7 Ah.
Battery Operating Time	Up to four hours of continuous operation at 23°C.
Battery Recharge Time	Four hours after complete discharge if analyzer is off. Approximately two hour for each hour of discharge from full capacity if analyzer of off.
Operator Error Alarm	User definable: none, double beep, error screen.

Chapter 2 Specifications

Concentration Alarm	Low, High, and STEL
Power Requirements of ac/dc Converter	95 to 260 V ac at 50/60 Hz, $\pm 3\%$ or 11 to 15 V dc, 5 A (from automobile battery with optional dc power cable)
Measurement Cycle Time	Single gas analysis screen updated each half-second. Dependent upon application in multigas mode or if compensations are enabled.
Reference, Operating, and Storage Conditions	See Table 2-2.
Electromagnetic Compatibility (EMC)	Complies with the requirements of the European EMC Directive 89/336/EEC.
Sample Flow Rate	14 liters/minute (nominal) with sampling wand and particulate filter.
Sample Cell Volume	2.23 liters
Gas Purging	5 volumes of sample required to purge cell by 99%.

Table 2-2. Operating and Storage Conditions

Influence	Reference Operating Conditions ^(a)	Normal Operating Conditions ^(b)	Normal Operative Limits ^(c)	Transportation and Storage Limits ^(c)
Ambient Temperature	23 \pm 2°C (73 \pm 4°F)	5 to 40°C (40 to 105°F)	1 and 50°C (35 and 120°F)	-20 and +60°C (-5 and 140°F)
Relative Humidity	50 \pm 10%	5 to 95% (noncondensing)	0 and 95% (noncondensing)	0 and 100% (noncondensing)
Ambient Pressure (d)	101.3 \pm 1% kPa (14.7 \pm 1% psi)	86 to 106 kPa (12.5 to 15.3 psi)	80 and 110 kPa (11.6 and 15.9 psi)	80 and 110 kPa (11.6 and 15.9 psi)
<p>(a) Range of operating conditions within which the influence is negligible.</p> <p>(b) Range of operating conditions within which a device is designed to operate and for which the specifications for the influence applies.</p> <p>(c) Range to which a device can be subjected without permanent impairment of operating characteristics. Device may require adjustment to restore specified performance upon returning within the limits of Normal Operating Conditions. Maximum temperature for intrinsically safe models is 40°C</p> <p>(d) Single pressure point within the range, pressure may not vary throughout the range.</p>				

Table 2-3. Physical Specifications

Item	Specification
Enclosure Material	Estaloc
Internal Sampling Lines	Corrugated Teflon
Detector	Pyroelectric lithium tantalate
Gas Cell	Standard - Bare Aluminum Optional - Teflon Coated
Lenses	Silver Bromide
Analyzer Dimensions	21.8 in (55.3 cm) wide 14.4 in (36.5 cm) high 7.6 in (19.3 cm) deep
Sampling Hose	Corrugated Polyethylene, 0.5 in (12.7 mm) O.D., 42 in (107 cm) long.
Weight	24 lbs (10.9 kg)

Table 2-4. Optional Electrical Safety Certifications

Testing Laboratory, Types of protection, and Area Classification	Application Conditions
ETL-C (Canada) intrinsically safe, Class I, Division 1, Groups B, C, and D.	Temperature Class T4.
ETL intrinsically safe, Class I Division 1, Groups B, C, and D.	Temperature Class T4.

Note: Intrinsically safe analyzers have been designed to meet the electrical safety descriptions listed in the table above. For detailed information or status or testing laboratory approvals/certifications, contact Thermo Environmental Instruments.

Chapter 3

INSTRUMENT PREPARATION

UNPACKING

Remove the instrument from its shipping carton and/or transportation case and check it for visible damage. If the instrument has been damaged, notify the carrier immediately and request an inspection report. Obtain a signed copy of the report from the carrier. Check the contents of the shipping package against Table 3-1; there should be one of each item. Immediately report any shortages.

Table 3-1. Packing List

Item	Description
1	SapphIRe Ambient Air Analyzer
2	Charger/Power Supply
3	Power Cable*
4	Battery Pack (shipped and installed in the analyzer battery compartment)
5	Chassis Interface Cable*
6	Battery Pack Interface Cable*
7	Shoulder Strap
8	Air Sampling Assembly
10	Particulate Filter
11	Zero Gas Filter
12	Printer Cable*
13	Serial Communication Cable*
14	Battery Door Key
15	Pathlength Change Tool
16	Unit Specific Application Setup Disk
17	Thermo Connect CD
*For identification of cables, see Figure 3-1	

Note: If the instrument is returned for any reason, use the original packing. Package all components in the same manner as they were when shipped from the factory.



Power Cord, 115V
N0249XS



Charger/Chassis Interface Cable
TR101TN



Charger/Battery Pack
Interface Cable
TR101TK



Printer Cable
TR101QX



Serial Communication Cable
P0170QW

Figure 3-1. Cable Identification

IDENTIFICATION

A data plate (Figure 3-2) or a metal identification plate (Figure 3-3), are located on the back of the instrument. The information contained on these plates may be required should the factory be contacted for technical information or repairs. The metal identification plate is required for intrinsically safe models and contains additional information.

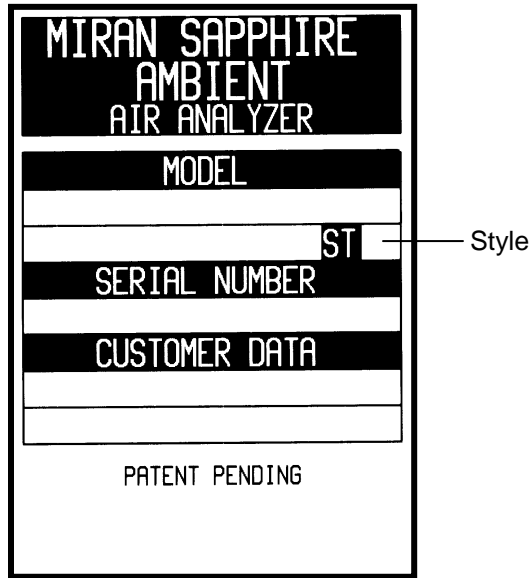

Figure 3-2. Data Plate

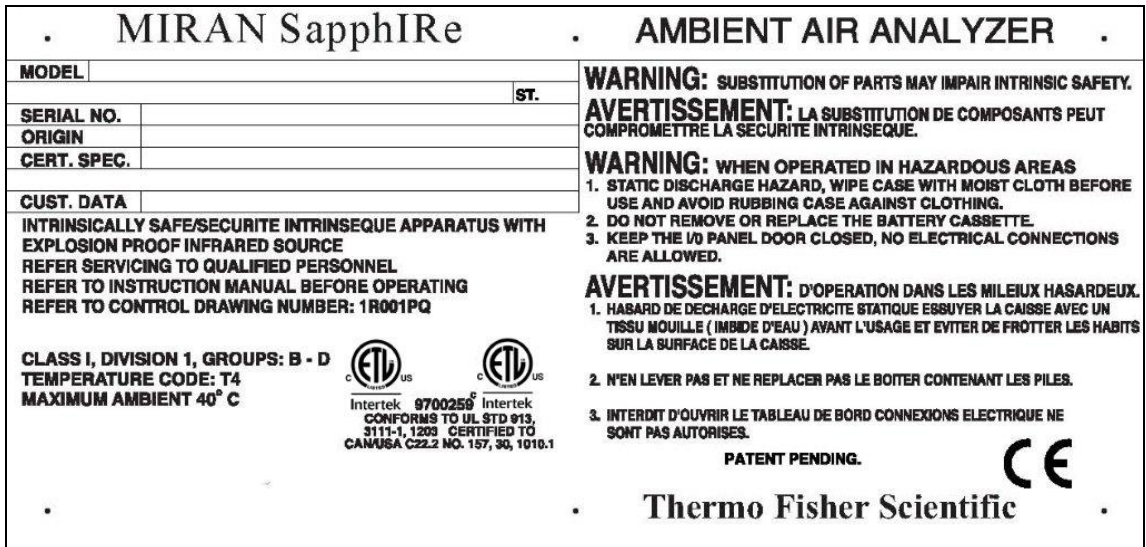

Figure 3-3. Metal Identification Plate

WAND (Optional) AND FILTERS

Caution: To prevent damage to the optics, never leave the inlet port uncovered. Always use a zero or particulate filter when pump is on, and cap both the inlet and outlet ports when not in use. Remember to remove the caps before using the analyzer.

The particulate and zero gas filters have been chosen for their low resistance to sample flow. Do not use substitute filters as they can cause erroneous readings. The particulate filter is used during gas analysis to remove dust and other particulates; the zero gas filter removes most infrared-absorbing components from the air and is used to set the analyzer zero before analysis.

Some gases are not removed by the standard zero gas filter (see page 5-1, Caution 2 for examples). These gases may absorb IR energy at the same wavelength being used for sample analysis. When such gases are present, use a source of clean air other than filtered ambient air when zeroing the analyzer.

To install the wand and filter, remove the protective covering from the analyzer inlet and outlet ports. Connect one end of the flexible hose to the inlet port and the other end to the handle of the wand. If the wand is used, first slide the leak probe ring over the hose, then attach the particulate filter to the end of the hose, and screw the wand onto the wand ring, making sure that the O-ring is properly seated.

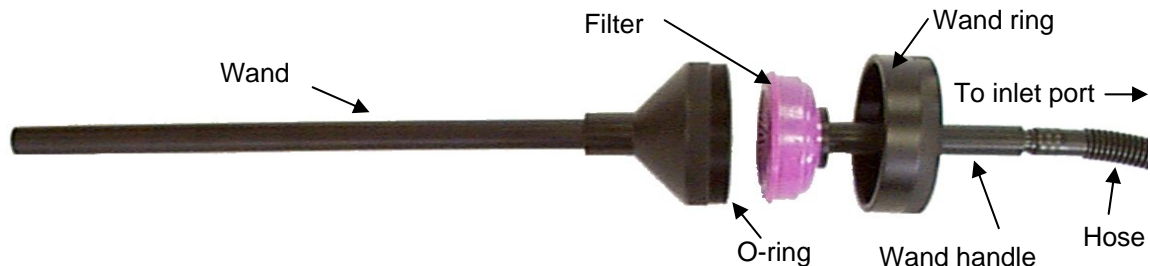

Figure 3-4. Wand (Optional) and Filter Installation

ADJUSTING SHOULDER STRAP

The analyzer has an adjustable shoulder strap that is listed in Table 3-1. To adjust the length of the strap, slide length adjustment until strap is desired length. Slide shoulder pad along strap to desired position.

CHARGER/POWER SUPPLY

Warning: Intrinsically safe models require special actions with respect to the following section. Refer to Appendix B for descriptions of these actions.

Note: The analyzer is shipped with a battery installed. The battery should remain installed, even when the instrument is running on ac power.

Charger

The charger/power supply provides operating power to the analyzer and charges the instrument's batteries. It may simultaneously power the instrument and charge the internal battery as well as charge a second battery externally using the included charger/battery pack interface cable. It may also charge two batteries externally (would require purchase of a second charger/battery pack interface cable). See figure 3-5 below

The charger can operate from 95 to 260 Vac, 50/60 Hz. The power connection is located on the back of the unit (see figure 3-6). It may also be powered by the optional 12Vdc cable for use in a standard car 12 Vdc connector (connection also on back of charger)



Figure 3-5. Model 5025A Charger/Power Supply



Figure 3-6. Rear of Charger/Power Supply

When either the instrument (with battery installed) or an external battery is connected to the charger, the ready light (green) goes out and the conditioning light (yellow) briefly appears. The charging light (amber) comes on and remains on until the battery is fully charged. At this point, the charging lamp turns off and the ready lamp appears. The time to fully charge a depleted battery pack is approximately four hours.

If a fully charged battery is connected to the charger, the above sequence is repeated, however the charging lights remains on for only a few minutes as it establishes the battery charge, then goes out and the ready light appears. The battery is now fully charged.

Battery Indicator Calibration

The purpose of the battery indicator calibration is to recalibrate the battery's internal computer chip. Since the battery's full run time is constantly diminishing by small amounts, the baseline must be constantly adjusted. This calibration procedure compensates for this change and recalibrates the system to ensure that the battery indicator presents as accurate a run-time as possible. A calibration should be performed:

- If there is a prompt to calibrate. This occurs after the analyzer has undergone 64 charge cycles without discharging and fully charging the battery.
- If the analyzer has gone unused for a period of 30 or more days.

Note: Not performing this calibration does not invalidate any of the concentration data.

Warning: Intrinsically safe models require special actions with respect to the following section. Refer to Appendix B for descriptions of these actions.

The calibration procedure is:

1. Remove the battery from the analyzer and connect it to the Charger/Power Supply using the battery pack interface cable. See Figure 4-3 for location of battery compartment. Open compartment using special key (Part Number X0173QH). Remove battery by partially turning each screw until the battery is loose.

Caution: The conditioning procedure cannot be performed on a battery that is installed in the analyzer. Do not press the Conditioning Start pushbutton while the battery is installed. This could damage the battery. It causes the red conditioning lamp to flash and the charger to return to its previous state.

2. Allow the battery to reach a fully charged state. This condition is recognized by the illumination of the green Ready lamp.
3. Press the Conditioning Start pushbutton. The green Ready lamp goes out and the red Conditioning lamp comes on. This indicates that the battery is being fully discharged, a process which takes up to five hours.
4. At the end of the discharge cycle, the red Conditioning lamp goes out and the amber Charging lamp comes on. This indicates that the battery is being brought to a full charge, a process that takes approximately four hours.
5. At the end of the charge cycle, the amber Charging lamp goes out and the green Ready lamp comes on. The battery is now fully charged and conditioned.

Battery Conditioning

Warning: Intrinsically safe models require special actions with respect to the following section. Refer to Appendix B for descriptions of these actions.

Battery Conditioning is slightly different than Battery Indicator Calibration. Conditioning the battery ensures that the battery does not develop a "memory" and that the battery maintains its full run-time potential. If the battery is typically run to complete or near complete discharge before recharging it, the conditioning procedure is not required. If the battery is typically run to only a partial discharge before recharging, then the battery should be conditioned every 5 to 10 cycles. The conditioning procedure is similar to the Battery Indicator Calibration procedure except delete Step 2.

ANALYZER OUTPUT CONNECTIONS

Warning: Intrinsically safe models require special actions with respect to the following section. Refer to Appendix B for descriptions of these actions.

The power and signal connection panel is located behind a hinged door on the analyzer. It contains a parallel port for output to a printer, a serial port for connections to a PC, and an output connection to provide 0 to 1 V dc analog and relay contact output. See Figure 3-7 for the location of each.

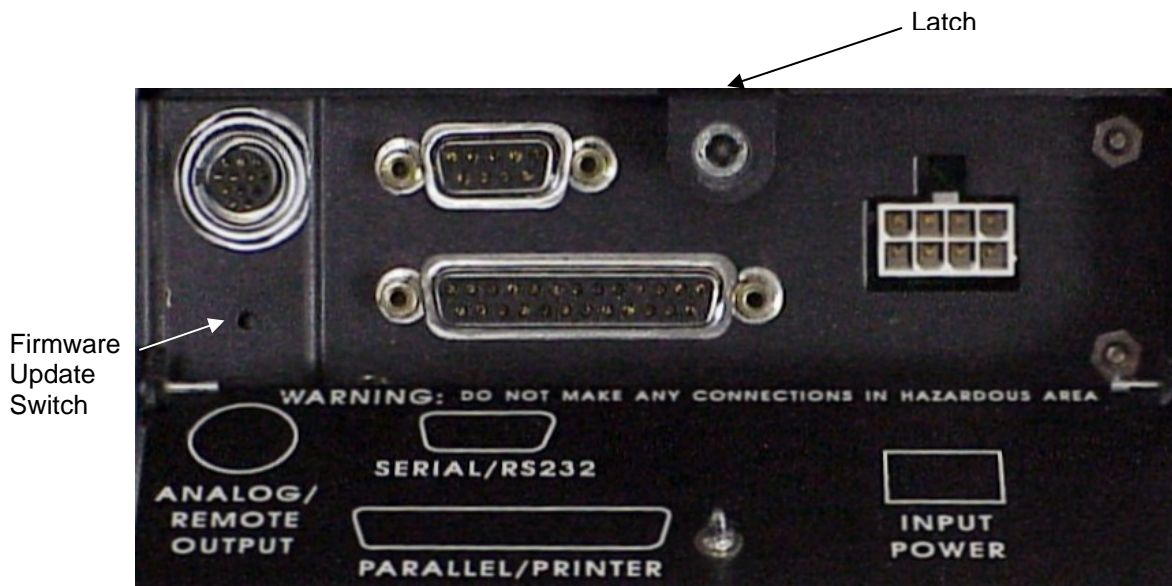

Figure 3-7. Location of Output Connections)

Chapter 4 OPERATION







CONTROLS AND DISPLAY

Operator controls and display are located on the front panel of the analyzer. Figure 4-1 shows the panel arrangement. Table 4-1 identifies the function of each key on the panel.

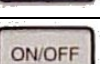
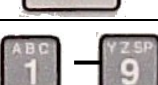

Figure 4-1. Controls and Display

Table 4-1. Function of Control Keys

Key	Function
MENU Key 	Steps through the choices in a menu.
SELECT Key 	Enters a highlighted menu choice; Duplicates the ENTER key.
ESC Key (Both) 	Cancels the current operation, clears the field, and acknowledges messages.
CONTROL Key 	Toggles the Control menu (to set various analyzer features) on and off.
ON/OFF Key 	Turns the analyzer power on or off.
Alphanumeric Keys 	Used to select numbered menu items and to make alphanumeric entries.
Arrow Keys 	Moves up and down through a menu. The Up arrow also is used as a backspace key.
ENTER Key 	Accepts data entries, triggers actions, and acknowledges messages.

Chapter 4 Operation



If the analyzer is running on battery power, the lower left corner of the display may indicate that the instrument is using battery power as well as the status of the battery. See Chapter 7, “Preferences” to activate or deactivate this feature.

PASSCODE ACCESS

Most operations with the SapphIRE analyzer are not passcode protected. However, the Analysis section of the Setup Menu can be secured with a passcode. The initial passcode is blank. The procedure to establish or change a passcode is described in Chapter 7, “Passcode”. Contact the factory if the passcode is lost and assistance is needed.

CONTROL MENU

The Control Menu can be accessed at any time by pressing the Control key. The Control Menu screen, shown below, allows the user to:

1. Turn display backlight on or off
2. Turn pump on or off
3. Turn sound (error beeps) on or off
4. Turn analog output on or off
5. Reset the alarms to inactive
6. If not logging, reset analysis interval statistics
7. View battery condition (time remaining, no battery, or invalid data)
8. Set screen contrast using the   keys

Warning: Intrinsically safe models require special actions with respect to these features. Refer to Appendix B for descriptions of these actions.

Note: If Analog Output is turned on in a multi-gas application, the analyzer presents a second display to select a gas to be assigned to the output.

Note: The display does not show the present condition; it shows the condition caused by pressing a number key. For example the Control Menu screen, below, shows that the backlight is presently off; pressing 1 turns it on.

```
CONTROL MENU
1=Backlight on      4=Analog out on
2=Pump on           5=Alarm clear
3=Sound off         6=Analysis reset
                   ⬆=Contrast adjust
Battery: 3:55
[ ████████ ]      Esc=Exit
```

Control Menu Screen

ENTERING ALPHANUMERIC CHARACTERS

Some setup and data entry fields use alphanumeric data. Entering alphanumeric characters is a two-step process. For example, to get the number "2" or the letters "D", "E", or "F", first press "2". The display then prompts "0=2, 1=D, 2=E, 3=F". To enter the letter "D", press "1". Use the letters printed on each key as a guide.

MAKING MENU SELECTIONS

The usual method of entering a selection is with the number keys. The three keys located above the screen provide an alternate selection method that is useful for gloved operation or for one-handed operation when the instrument is worn on the hip. To use this method, press the Menu key until the desired selection is highlighted. Then press the Select key to enter the selection or the escape key to exit from the operation (also see Table 4-1).

MENU STRUCTURE

All of the SapphIRe menus are accessed from the Main Menu. Figure 4-2 shows the structure of the main menu and sub-menus. The chapters describing the functions of each sub-menu are also noted.

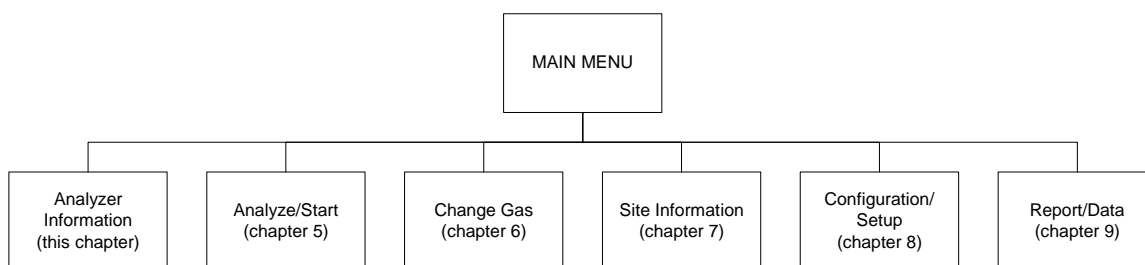
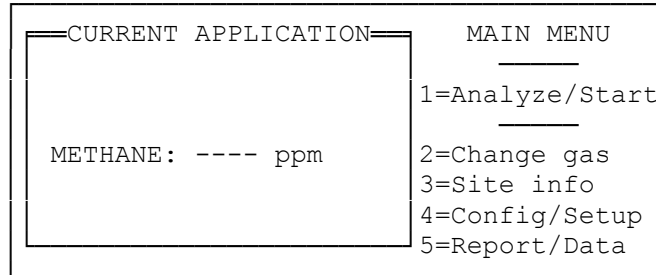

Figure 4-2. Main and Sub-Menu Structure

STARTUP PROCEDURE

Press the ON/OFF button to activate the instrument. The first menu to appear is the Main Menu, shown below.

If the application shown on the Main Menu is the one that is wanted, press “1” or ENTER to display the Zero Menu, shown on page 4-6.



Main Menu

If an application other than that on the Main Menu is desired, press **2** to display the Select Applications menu shown below. This menu presents up to five of the most recently selected applications. If one of the applications shown in this menu is selected, the display skips to the Zero menu, shown below.

Note: Any application in the Select Applications menu will be removed when a new application is downloaded from a PC. These applications are not removed from the instrument, and can be accessed from the user libraries via the Applications menu, shown below.

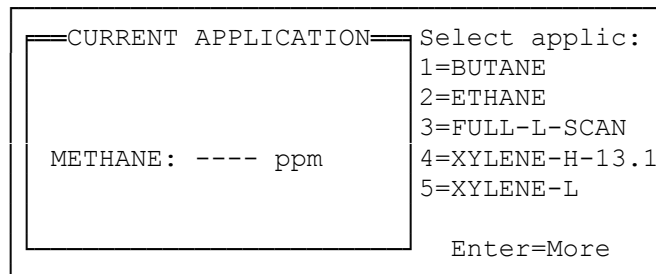

Select Applications Menu

The Select Applications menu will be omitted if no previous applications have been selected, and the Applications menu will be displayed. If none of the applications appearing in the Select Applications menu are desired, press ENTER to view the Applications menu, shown on page 4-5.

```

CURRENT APPLICATION      APPLIC MENU
METHANE: ---- ppm      1=Standard lib
                        -----
                        User libraries:
                        2=Single gas
                        3=Multi-gas
                        -----
                        4=Spectrum scan

```

Applications Menu

Select an application in the Primary Applications menu from the SL or XL standard library, or from the single or multi-gas user libraries. The XL Standard Library menu is shown in this example.

```

CURRENT APPLICATION      STANDARD LIB
METHANE: ---- ppm      1=111TRICL
                        2=11DICLOR
                        3=12DICLOR
                        4=13BUTADI
                        5=2CLETH
                        ▲=More
                        ▼=Search
                        ENTER=Search

```

Primary Applications Menu

Scroll the pages of the library with the arrow keys. In the standard library, there is more than one screen of choices, which can be selected by pressing the arrow keys or pressing the ENTER key to use the search mode and follow the screen prompts. If in the user library, there is more than one screen of choices, use the arrow keys.

In either the standard library or in the user library, make a selection using the number keys or MENU and SELECT. Upon selection, the display responds "ACCEPTED" and returns to the Main Menu, showing the selected application in the left window (Current Application).

Chapter 4 Operation

If an application has more than one wavelength, a Secondary Application menu appears. An asterisk appears next to all secondary applications. Make a selection using the number keys or MENU and SELECT. Upon selection, the display responds “ACCEPTED” and returns to the Main Menu (see Chapter 6, “Secondary Applications” menu, for more information).

```

CURRENT APPLICATION  ACETONE
1=11.0 2000
2= 8.4 2000*
METHANE: ---- ppm

```

Secondary Applications Menu

To start the analyzer and take measurements using the newly selected application, press **1** from the Main Menu. The Zero Menu screen, shown below, appears if a zero has previously been taken.

Note: If the analyzer has recently been zeroed, press ENTER and the display skips to the Analysis menu, shown below. Thermo Fisher Scientific recommends zeroing before each analysis session.

```

CURRENT APPLICATION  ZERO MENU
Last zero:
01Jan01 13:30
Status: Valid
1=New zero
Enter=Continue
METHANE: ---- ppm

```

Zero Menu

To establish a new zero, press “1”. In the unlikely event that the instrument is experiencing problems, the display indicates “Please wait...” and/or “Please wait while system warms up...”. To view the details on the Warm Up Status screen, Press “1”. In the example screen, both the chopper is not locked at the proper frequency and the filter is not properly positioned. In cases like this, contact the factory for assistance.

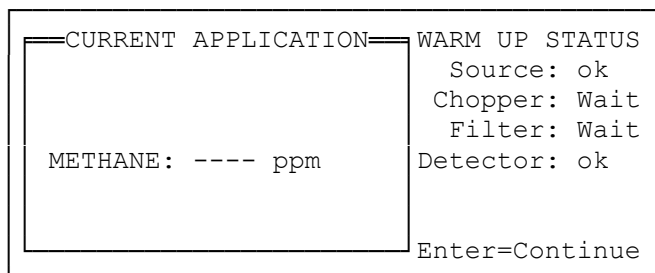

Warm Up Status Screen

If the analyzer mode is not zero, or scan, and pressure compensation is configured ON, the display shows the previously entered pressure and allows accepting or changing it (see Chapter 7, “Pressure Compensation”, for configuration). If a new pressure is entered, the display responds “ACCEPTED” or presents an “!INVALID VALUE!” message.

Note: SapphIRe does not measure pressure. This must be determined from an external source, and entered by the user at the beginning of each analysis.

Next, the analyzer checks its pathlength. The analyzer is set to one of two pathlengths; short (0.5 m) or long (12.5 m). If the pathlength is not correct for the application, the display prompts to change the pathlength. See “Changing the Pathlength”, in this chapter.

The instrument then displays the Install Chemical Filter screen, shown below. When the chemical (zero gas) filter is connected to the IN port, press ENTER.

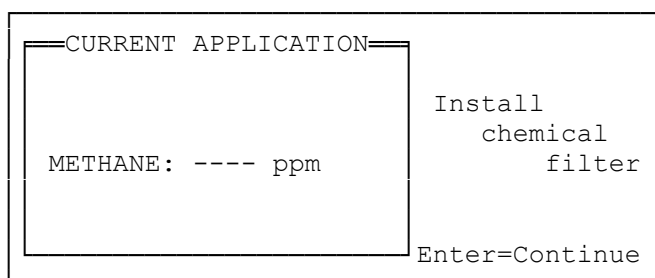

Install Chemical Filter Screen

Chapter 4 Operation

While the cell fills with zero air, the Zero Purge screen indicates the time remaining. Press ENTER to shortcut the purge.

CAUTION: The zero process requires five volumes of air (about 11 liters) to completely flush the cell. Shortcutting this step will result in an incomplete purge and incorrect readings during analysis due to an invalid baseline value.

```

CURRENT APPLICATION
METHANE: ---- ppm
Wait for cell
to fill with
zero air...
15 seconds
Enter=SkipPurge
```

Zero Purge Display

The instrument automatically begins the zeroing process. Wait while the zero measurement is taken. The screen displays the percent done. Use the up and down arrow keys to toggle the measurement views.

```

CURRENT APPLICATION
METHANE: ---- ppm
Wait while
zeroing...
[ 50% ]
Esc=Cancel
```

Zeroing Process Display

If the instrument is not set up for zero autosave mode, the display asks to save the new zero. Press “1” to repeat the zeroing procedure or ENTER to save the zero. The display responds “ZERO SAVED.”

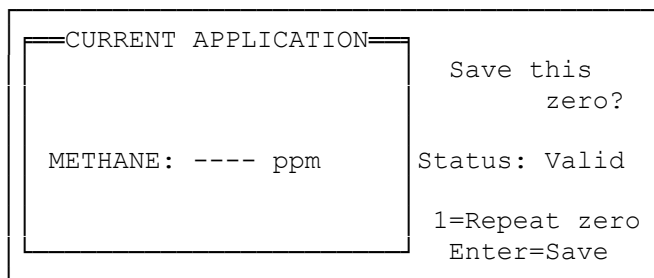

Zeroing Save Display

The instrument then displays the Install Particulate Filter screen, shown below. When the filter is connected to the IN port, press ENTER.

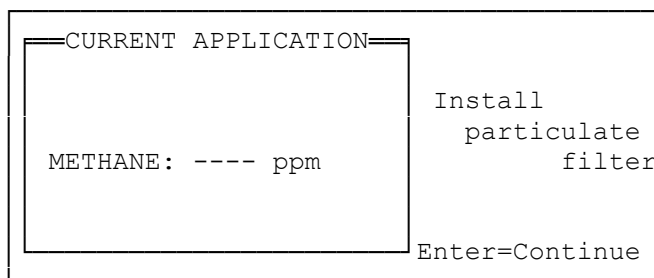

Install Particulate Filter Display

Wait for the sample to fill the cell. The filling progress is shown on the display. Press ENTER to shortcut this procedure. If the purge is skipped, wait about 10 seconds for the cell to reach equilibrium. Press “1” to start logging as soon as the sample fill is complete.

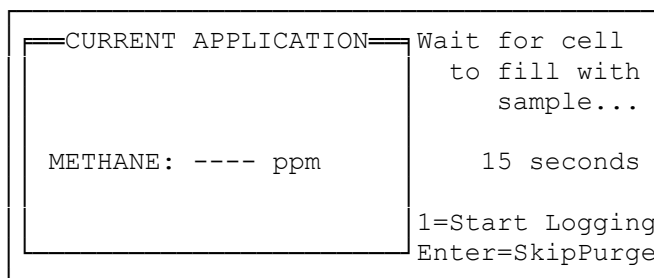

Purge Process Display

Chapter 4 Operation

When the purge is complete, the display changes to the Analysis menu. The bands above and below the left portion of the display indicate that the analyzer is actively making measurements.

Note: The location on the bottom line of the Analysis Menu and choices 3, 4, and 5 do not appear unless the location mode is enabled.

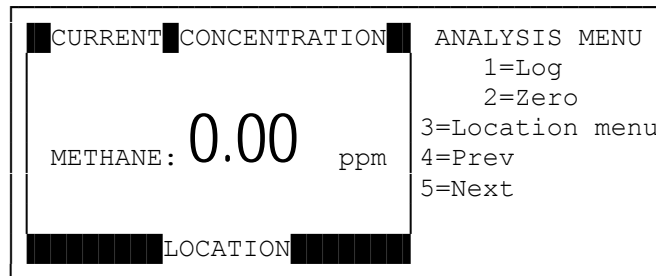

Analysis Menu

Note: The black bands above and below the left portion of the screen indicate that the analyzer is actively making measurements.

USING THE SEARCH FEATURE

If searching for a chemical in the standard library or for a location in the location list, scroll through the list or alternatively use the search feature if the list has more than one screen of selections. To use the search feature, access it via the Primary Applications Menu (See Primary Applications Menu) or the Location List Menu (See Location List Menu). Then enter the first letters of the name that is being searched for. Press ENTER to accept.

CURRENT	CONCENTRATION	Add or search
		for location:
METHANE:	0.00 ppm	B
		▽=Next match
		Press char key
		△=Backspace
		Enter=Accept
LOCATION		

Add/Search Location

Example: If searching for Bedroom 2, enter 'B'. Display may show

B AR

Press the down arrow for next match. Display may show

B EDROOM

Press the down arrow for next match. Display may show

B EDROOM1

Press the down arrow for next match. Display may show

B EDROOM2

Press ENTER to accept.

Note: To bring up a more selective choice, enter the first few letters; for example "BE" to skip the location bar and begin the search at "bedroom".

Note: The up arrow clears the preceding character; it does not navigate upwards through the list.

INFORMATION SCREENS

The following information regarding the analyzer is presented on information screens. To access these screens, press "0" from the Main Menu. Press ▲ or ▼ to access additional information screens. Press "ESC" to return to the Main Menu.

- Model
- Serial Number
- Software Version
- Dates of Last and Next Service
- Concentration Calculation (installed or not)
- Spectrum Scan (installed or not)
- Optional Temperature Sensor (installed or not)
- Manufacture Date
- Standard Library (installed or not)
- Full Library (installed or not)
- Enhanced Library (installed or not)
- User Library (installed or not)
- Gas Cell Material
- Chopper (standard or custom)
- Detector Material
- Filter (standard or custom)
- Intrinsically Safe (or not)
- Pathlength Changer (installed or not)
- Sample Temperature Sensor (installed or not)
- Ambient Temperature Sensor (installed or not)
- Analyzer Control Software Version

ERROR SCREENS

The SapphIRE analyzer displays one of several error screens if certain problems occur. The message is identified as an ERROR, WARNING, or ALARM. An error beep or continuous alarm also occurs. Acknowledge these messages by pressing the ESC or ENTER key. The acknowledgment returns the user to the previous screen layer.

Table 4-3. Error Messages

Error Message	Meaning	Corrective Action
Application processing error!	This is a general error message that indicates there was an error during analysis or with an application that doesn't allow the analyzer to continue analysis. The second line of this error message indicates specifically what caused the error. Numerous fault conditions could result in this error.	If a message is not understood, make a note of the second line of the error screen, and call for assistance.
Clock update has failed!	This error message indicates that the real-time clock hardware could not be updated.	Contact service for assistance.
Measurement problem detected!	If any of the measurement flags are generated during analysis (such as invalid purge, invalid zero, fault, calibration overflow, calculation overflow, A/D overflow/underflow), this error may appear.	This error message may be disabled permanently by pressing 1 on this error screen or by shutting off the "Fault action" parameter in the preference menu from the Analysis Setup Menu #1.
Spectrometer communication error!	The data received from the spectrometer controller board is not valid. This could be caused by a communications error with the spectrometer controller board.	If this happens frequently, return the instrument for service.
Spectrometer is not ready!	This error message indicates that a component in the spectrometer is not ready. This could be caused by the chopper motor not operating at the correct speed, or the IR source or detector not functioning correctly.	If this error is displayed wait a few seconds and retry the operation. Also check the battery level and attempt to plug into AC power if the level is low. If the error persists, press 0 (zero) to identify error, and call for assistance.

Table 4-4. Warning Messages

Warning Message	Meaning	Corrective Action
Absorbance is too negative! Try rezeroing the analyzer and make sure zero gas is not contaminated.	This message is generated if the measured absorbance falls below a negative absorbance threshold value set in the application. Try rezeroing the analyzer to correct the problem	Rezero the analyzer. If problem persists, replace the zero gas filter.
Analyzer factory configuration is invalid!	This message is displayed only during the power-on self-test if the factory configuration is not valid. The analyzer can operate with a minimum feature set.	Return analyzer for service.
Analyzer memory is invalid.	The data in the analyzer's battery-backed up RAM is invalid. All settings are reset to factory default values if this message is displayed. If the analyzer power is cycled again and this message persists, the backup battery may be dead.	Contact service for assistance.
Battery pack capacity getting low!	This message indicate the battery pack has reached the end of its lifetime.	Replace the battery pack with a new one.
Battery pack charge is low! Not enough power to run analyzer.	This message indicates the battery is too low to run the system. The system is shut down shortly after this message is displayed.	To continue operation, replace the battery with a fresh battery or connect the analyzer to a charger.
Battery pack data is invalid!	This message indicates the battery pack has not been initialized.	Contact customer service for a new battery pack.
Battery pack needs full charge, then discharge to update capacity data.	This message is displayed if the battery has not been fully discharge before it has been recharged many times.	Perform battery indicator calibration (see page 3-7).

Table 4-4. Warning Messages (continued)

Built-in clock's date/time is wrong!	This message is only generated during the initial self-test on powerup. It indicates that the time reported by the real time clock hardware is invalid. When this message is displayed, the clock is set to a valid time. If the analyzer power is cycled again and this message still appears, the backup battery may be dead.	Contact service for assistance.
CHECK PRINTER!	This message appears if a printer attached to the printer port is reporting an error condition such as: out of paper, offline, or error.	Clear the status at the printer.
Log data memory invalid! All sites cleared. Probable cause is turning power off during memory access.	This message indicates that the analyzer found a problem in the data stored in logging memory. This could be caused by the analyzer's power being interrupted during a memory write or by low backup battery. If this message appears, all logged data is deleted. Try logging the data again.	Ensure the analyzer is properly powered. If the problem persists, call service for assistance.
Pathlength setting is wrong.	This warning message appears if the pathlength setting is changed to an invalid position during analysis.	Set the pathlength changer back to the correct position and restart analysis.
RECOMMENDED SERVICE IS DUE!	This message appears when the analyzer's next service date has passed. Annual maintenance reduces field breakdowns. Note that normal operation is possible should this message appear.	Contact service for a service update.
Spectrometer startup has failed! Try powering off, then back on.	This message is displayed only during power-on self-test if communications cannot be started with the spectrometer controller board. As the message states, try powering off the analyzer and then turn it on again.	Cycle power off/on. If the message persists, return the analyzer for service.
Watchdog timer has reset the system!	This warning message is displayed only during the power-on self-test if the system was reset by the watchdog. As the message indicates, this error is most likely caused by a software problem.	Note what the analyzer was doing before it shut off, and contact service for assistance

CHANGING THE PATHLENGTH

The SapphIRe analyzer can be set to one of two pathlengths: short (0.5 m) and long (12.5 m). To change the pathlength from the short pathlength (0.5 m) to the long pathlength (12.5 m), turn the hex recess adjustment clockwise with the pathlength change tool or 9/64 hex wrench. The location of the pathlength adjustment is shown in Figure 4-3. To change the pathlength from long to short, turn the adjustment counterclockwise. See Location of Pathlength Adjustment for location of adjustment.

Caution: Do not overturn adjustment.

The rotation angle is approximately 90 degrees but the actual short path position corresponds to the point at which a push pin engages a notch in a cam. As the pin and cam are aligned, an indicator rod engages a microswitch which tells the microprocessor that the gas cell is now at short path.

As the mechanism is being changed from the long to short position, there is a slight increase in resistance to turning the adjustment. This is normal (caused by the compression of an internal spring) and should not be construed as a defect. An audible "click" indicates when the mirror is in the proper position.



Figure 4-3. Location of Pathlength Adjustment and Battery Compartment

ANALOG OUTPUT

Warning: Intrinsically safe models require special actions with respect to the following section. Refer to Appendix B for descriptions of these actions.

The SapphIRe analyzer is equipped with a 0 to 1 V dc analog output jack (see See Analyzer Output Connections, Figure 3-8). This output is linear with concentration and is assigned to a gas in a single gas application. In a multi-gas application, the analog output must be assigned to the gas. The output is linear with the High Range Limit (HRL) (see See Gas High Range Limit). For example, if the HRL is set to 50 ppm and the analyzer is displaying 25 ppm, the analog output is 0.5 V dc. If the HRL is set to 100 ppm and the analyzer is displaying 25 ppm, the analog output is 0.25 V dc.

INSTRUMENT ORIENTATION

The SapphIRe analyzer can be used in primarily two positions: (1) vertical with the handle facing up and (2) horizontal with the display facing up. Either position is acceptable for analysis. However, because of gravitational forces on the motor mechanism, which drives the wavelength system, the most stable position is horizontal.

Furthermore, there can be differences in the displayed data when the analyzer is zeroed in the horizontal position and used for analysis in the vertical position or vice versa.

When performing any (spot checking or long term) analysis, Thermo Fisher Scientific recommends that the unit be placed in the horizontal position. Certain applications can cause problems when in the vertical position. For example, if measuring very high concentration samples of dense gases, it is possible that sample may settle to one end of the cell. High concentration anesthetic gas analysis can cause this phenomenon. To solve the problem, place the analyzer in the horizontal position.

Chapter 5

ANALYZE/START

To start the analysis, press **1** (Analyze/Start) from the Main Menu. The display presents the Zero Menu if a zero has been taken for all of the current application wavelengths. The date and time of the last zero and analyzer status are shown. To re-zero the analyzer, press **1**. To continue with an analysis without taking a new zero value, press **ENTER**.

Note: If the analyzer has not been recently zeroed, the analyzer skips the Zero Menu and displays the Analysis menu. See “To Begin Analysis” later in this chapter.

CURRENT APPLICATION	ZERO MENU
METHANE: ---- ppm	Last zero: 04Jan01 13:30
	Status: Valid
	1=New zero Enter=Continue

Zero Menu

TO ZERO THE ANALYZER

Caution:

1. When zeroing the analyzer, it is important to zero the unit in the area where the analysis is to take place. This assures that the analyzer is zeroed with air (scrubbed by the zero gas filter) at the same temperature and humidity as the sample to be analyzed.
2. However, for chemicals such as Butane, Carbon Dioxide, Carbon Monoxide, Ethane, Methane, Nitrous Oxide, Propane, and Water Vapor, that can not be scrubbed by the zero gas filter, it is important zero the unit in an area free of the chemical. For example, if methane is being measured, zero the analyzer in a Methane free area. (Note: typical atmospheric conditions are 2-3 ppm.) If the analyzer is zeroed in an area containing 7 ppm of Methane, the zero value is set at 7 ppm. All subsequent readings are then referenced to the 7 ppm baseline value. Thus, if Methane rises to 15 ppm, the analyzer displays a reading of 8 ppm; if it drops to 3 ppm, the display reads -4 ppm.
3. Thermo Fisher Scientific recommends that the zero gas filter be replaced after 30 zero cycles.
4. The purging of the gas cell during the zero process requires five volumes of air (about 11 liters). The timing supplied in the analyzer's zero routine is ample to allow for this to happen. However, if there is a restriction in flow that reduces the sample flow rate below approximately 11 liters/minute or if the sample hose is lengthened, it is possible that the cell may not be satisfactorily purged under these conditions. If so, repeat the zero process until sufficient sample has been drawn through the zero filter.

Chapter 5 Analysis

To re-zero the analyzer, press **1** (New zero) from the Zero Menu. The display responds with "Please wait..." and/or "Please wait while system warms up...". When all areas are indicated "ok", press **ENTER** to continue. If the Analyzer mode is not zero, or scan and pressure compensation is configured On, the display shows the current pressure compensation and gives the user the opportunity to accept or change it. If a new pressure is entered, the display responds "-ACCEPTED-" or presents an "!INVALID VALUE!" message. Next, the analyzer checks its pathlength. The analyzer is set to one of two pathlengths; short (0.5 m) or long (12.5 m). If the pathlength is not correct for the application, the display prompts the user to change the pathlength (see Chapter 4, "Changing the Pathlength").

```
┌───────────────────┐
│ CURRENT APPLICATION │
├───────────────────┤
│                     │
│ METHANE: ---- ppm  │
│                     │
│                     │
└───────────────────┘
Enter=Continue
```

The display next prompts for the installation of the chemical (zero) filter on the connector as shown in Figure 3-4. When this is done, press **ENTER**.

Install Chemical Filter Display

```
┌───────────────────┐
│ CURRENT APPLICATION │
├───────────────────┤
│                     │
│ METHANE: ---- ppm  │
│                     │
│                     │
└───────────────────┘
Enter=SkipPurge
```

Wait for the cell to fill with zero air and for the zeroing process to occur. Press **ENTER** to shortcut the purge.

Zeroing Process Display

Caution: The zero process requires five volumes of air (about 11 liters) to completely purge the cell. Shortcutting this step can result in an incomplete purge and a faulty baseline value. If **ENTER** is pressed to skip the purge, a message is displayed citing the need to completely flush the cell. If the purge continues to be skipped, an error flag ("Z") appears next to the displayed data because the automatic routine has been overridden. Any measurement data is flagged with a "Z" for invalid data. Yet, it is possible that the data is perfectly acceptable.

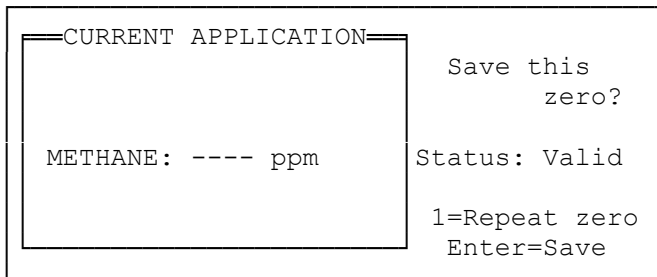

If zero autosave is not enabled, the display asks to save this zero. Press “1” to repeat the zeroing procedure or ENTER to save the zero. The display responds “ZERO SAVED.”

Save Zero Display

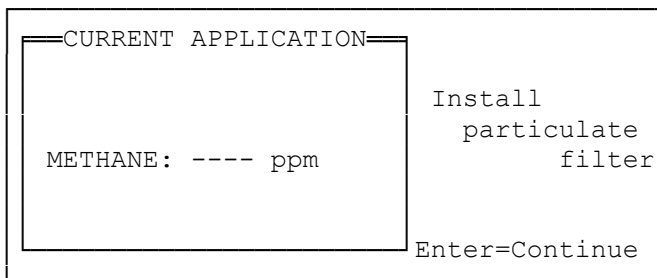

The display then prompts the user to replace the chemical filter with the particulate filter. When this is done, press ENTER.

Install Particulate Filter Display

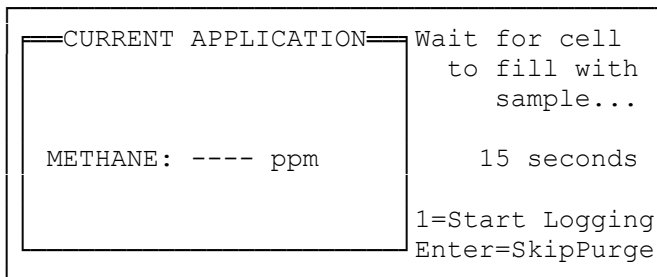

Wait for the cell to fill with sample. The filling progress is shown on the display. When completed, the display changes to the Analysis menu. Press ENTER to shortcut this procedure. If the fill cycle is skipped, wait for the cell to reach equilibrium, which takes about 10 seconds. If logging is configured, and a site has been created, “1=START LOGGING” is displayed. Pressing “1” will start logging as soon as the purge cycle has been completed.

Purge Process Display

Caution: If ENTER is pressed to skip the purge cycle, a message is displayed citing the need to completely fill the cell. If the purge cycle is skipped, an error flag, "P", appears next to the displayed data. Any logged data is also flagged with a "P" for insufficient purge. This indicates that the sample fill cycle has been overridden and that the cell may not have been completely filled with sample. The first few displayed data points may be lower than expected. However, after the application's purge time has expired (typically 60 seconds), the analyzer should be displaying the concentration of the external sample and the error flag is erased.

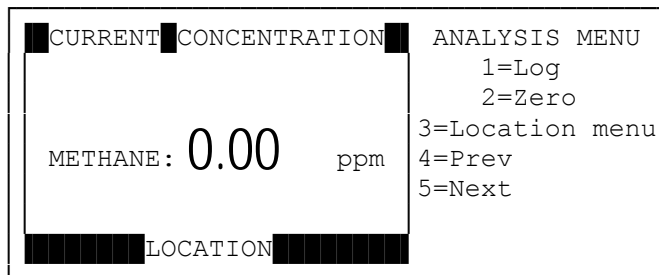

The heavy bands above and below the left portion of the display indicate that the analyzer is actively taking measurements.

Note: Location and selections 3, 4, and 5 do not appear unless the location mode is enabled.

Analysis Menu

TO BEGIN ANALYSIS

If the user chooses not to rezero the analyzer, or when the rezero procedure has been completed, the display presents the Analysis Menu (see Analysis menu, above). The active measurement is displayed on the left and the menu of selections on the right.

Note: The black bands above and below the left portion of the screen indicate that the analyzer is actively making measurements.

In addition to reading Current Concentration, the user can view data of the following on the left side of the display by using the up or down arrow key if so configured (see Chapter 7, "View Enable").

- Absorbance
- Average Concentration
- Maximum Concentration
- Maximum Concentration Time
- Minimum Concentration
- Minimum Concentration Time
- STEL Concentration
- STEL Maximum Concentration
- STEL Maximum Concentration Time
- Intensity

LOG

The Log function saves measurement values for later downloading to a PC or printer. To begin the log function press 1 (Log) from the Analysis Menu.

If a site has not been created, the display reads "Must start site before logging!" If logging was not set up, the display reads "Logging is not configured!"

If the timed log feature is active but not started, the display reads "Wait for start of timed log..." Wait for the timer to time out or press ENTER to start logging now.

When logging begins, the display reads "Log in progress" and the time or samples remaining. When logging is completed and if save is manual, the display asks "Save this log?" Press 1 to repeat the logging procedure or ENTER to save the log. If saved, the display reads "-STORED-."

To stop logging, press the ESCAPE key. This has no impact on the current analysis.

ZERO

The Zero function gives the user another opportunity to zero the analyzer. To begin this function, Press 2 (Zero) from the Analysis Menu. The remainder of the procedure is the same as that explained earlier in this chapter in "To Zero the Analyzer."

LOCATION NAME

The Location Name function enables the user to identify the location of the analysis. The present location Name appears on the bottom left of the Analysis Menu screen if the Location mode is enabled. If the user wants to change the location, press 3 (Location name). The display presents the Location List Menu (see Location List menu, below). If the previous or next location is desired, press 4 (Previous) or 5 (Next) respectively.

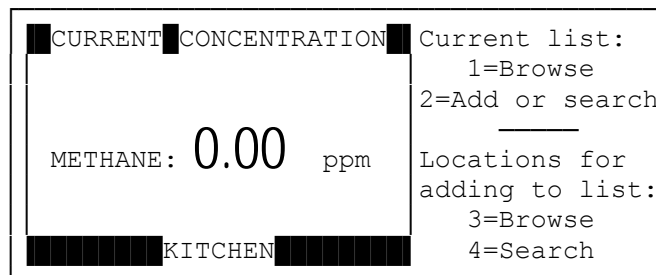

Location List Menu

Chapter 5 Analysis

To review the Location List or to select a location name, press 1 (Browse). If no locations are in the current list, the display reads "Location list is empty." If locations are listed, select the location name using the MENU and SELECT keys or the number keys. The display responds "-ACCEPTED-".

To search for a location name, press 2 (Add or search). The Add or Search screen is displayed (see Add/Search screen, below). Enter the first letters of the location name, and Press ENTER to accept.

Example: If searching for Bedroom 2, enter "B". Display may show

B AR

Press the down arrow for next match. Display may show

B EDROOM

Press the down arrow for next match. Display may show

B EDROOM1

Press the down arrow for next match. Display may show

B EDROOM2

Press ENTER to accept.

Note: To bring up a more selective choice, enter the first few letters; for example "BE" to skip the location bar and begin the search at "bedroom".

To add a new location, key in the entire new location name and press ENTER. The new location appears in the shaded band below the concentration value. There can be up to 200 locations per site. Locations can also be kept in a supplemental list. To browse this list, press 3 (Browse) from the Location List Menu. To search for a name on this list, press 4 (Search). For more details, refer to Chapter 8.

CURRENT	CONCENTRATION	Add or search for location:
METHANE:	0.00 ppm	<input type="text"/>
LOCATION		▽=Next match Press char key △=Backspace Enter=Accept

Add/Search Screen

ERROR/FAULT MESSAGES

The instrument displays error/fault messages relating to analysis by indicators on the display or by flag screens.

Display Indicators

A letter or symbol at the end of the analyzer reading indicates the following:

Table 4-2. Display Indicators

Symbol	Description
H	High alarm level exceeded
L	Low alarm level exceeded
S	Short Term Exposure Limit alarm level exceeded
X	Fault/error
P	Purge not done
Z	Zero invalid
>	Concentration exceeds full scale value (HRL).
▽	Measurements are below the range of the measurement electronics. Possible corrective action is to rezero the analyzer or change the pathlength.
△	Measurements exceed the range of the measurement electronics. Possible corrective action is to rezero the analyzer or change the pathlength.
}	Calculation overflow where range has been exceeded for processing a measurement value. Possible corrective action is to repeat the measurement.

Flag Screens

In the analysis mode, the SapphIRe analyzer displays flag screens if other problems occur. Acknowledgment is not required for flag screens. A summary of active flags and corrective action recommendations can be viewed by pressing the "0" key from the Analysis Menu.

Table 4-5. Flag Messages

Flag	Corrective Action Recommendation
Light source unstable or invalid	Make sure warm-up is complete.
Pathlength unstable or wrong setting	Check pathlength position.
Light chopper unstable or failed	Service may be required.
Optical filter unstable or failed	Service may be required.
Detector unstable or not ready	Make sure warm-up is complete.
Electronic Gain unstable or invalid	May need to zero analyzer.
A/D converter processing error	Try again and notify service.
Digital signal processing error	Try again and notify service.
Internal spectrometer related error	Notify service.
Detector signal is below A/D converter range	May need to zero analyzer.
Detector signal is above A/D converter range	May need to zero analyzer.
High range of calibration exceeded	Change application or recalibrate.
Software variable range exceeded	Try again and notify service.
Error during concentration calculation	Try again and notify service.
Measurement using an invalid zero	Rezero analyzer.
Zero and measurement gains bad or inconsistent	Rezero analyzer.
Ref wavelength intensity invalid	Notify service.
Ref wavelength intensity drift too large	Rezero analyzer.
Ref drift from factory value too large	Seek service.
Zero intensity levels out of nominal range	Try rezero, may need service.
Measurement made before purge complete	Wait for purge to complete.
Undefined	Notify service.

Chapter 6

CHANGE GAS

To change an application, press **2** (Change application) from the Main Menu. If one or more applications have previously been selected, the display presents the Recent Applications Menu in alphabetical order (see Recent Applications menu, below). The current application is shown on the left and up to five other recent applications on the right. Select one of the applications shown or press **ENTER** to view the Applications Menu to access the standard (fixed) library, single gas or multi-gas user library, or spectrum scan (see Applications menu, below).

Note: If the Recent Applications Menu is empty due to a firmware update or a factory reset, the analyzer proceeds directly to the Applications Menu.

```

CURRENT APPLICATION      Select applic:
-----
METHANE: ---- ppm      1=BUTANE
                        2=ETHANE
                        3=FULL-L-SCAN
                        4=XYLENE-H-13.1
                        5=XYLENE-L
                        Enter=More

```

Recent Applications Menu

```

CURRENT APPLICATION      APPLIC MENU
-----
METHANE: ---- ppm      1=Standard lib
                        _____
                        User libraries:
                        2=Single gas
                        3=Multi-gas
                        _____
                        4=Spectrum scan

```

Applications Menu

Once a selection has made from the Applications Menu, scroll the pages with the arrow keys if the choice contains more than one page of selections. Make a selection using the **MENU** and **SELECT** or the number keys. The display responds "-ACCEPTED-." If there is more than one page of selections and the analyzer is not in the User Library, the analyzer can alternatively go to a search mode by pressing the **ENTER** key. See Primary Application menu, below.

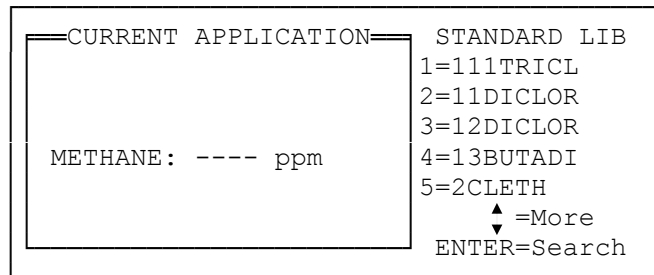

Primary Applications Menu

If the instrument is a SapphIRE-SL or SapphIRE-XL, a Secondary Applications menu might appear, providing alternate application wavelengths. For example, if Acetone is chosen from the Primary Applications Menu, the Secondary Applications Menu appears, as shown below, in the Secondary Applications menu. The chemical names are interpreted as follows: The *11.0* refers to the analytical wavelength and the *2000* refers to the full scale value. The asterisk (*) next to the 2000 indicates the alternate choice for application. For more information on the SapphIRE-SL and SapphIRE-XL analyzers, refer to Chapter 1, "Introduction."

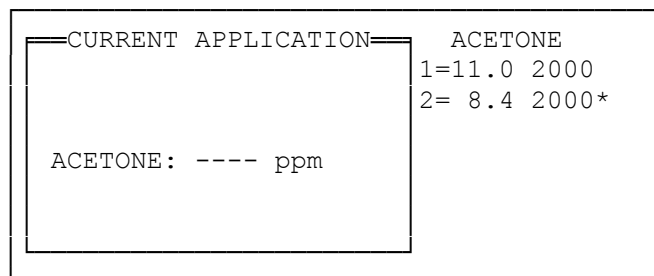

Secondary Applications Menu

Once a selection is made from the Secondary Applications Menu, the display responds "-ACCEPTED-."

In the above example, Acetone can be analyzed at either 8.4 microns or 11.0 microns. Both calibration ranges are 0 to 2000 ppm. In Figure 6-1, Acetone is present with Methyl Acrylate. The figure shows that Methyl Acrylate has a strong absorbance peak at 8.4 microns. In order to avoid interference from Methyl Acrylate when analyzing Acetone, the analysis should be performed at 11.0 microns. Note that Methyl Acrylate does not absorb at 11.0 microns.

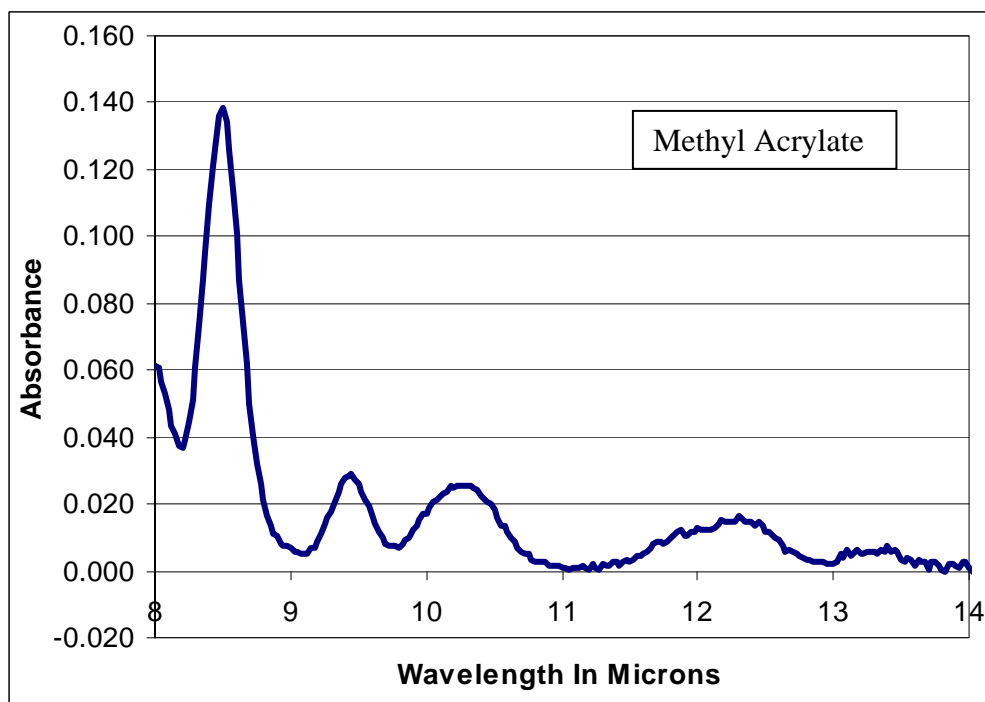
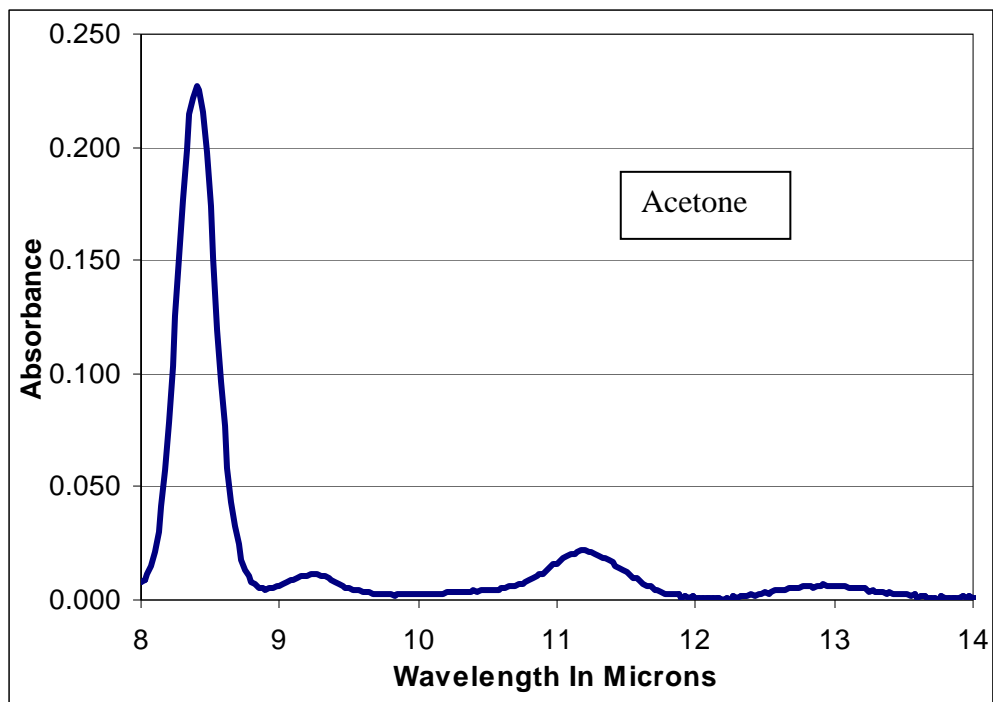

Figure 6-1. Alternate Wavelength Example

To effectively use the alternate wavelengths, refer to a book of infrared spectra or access an internet web site such as <http://webbook.nist.gov/chemistry>). Alternately, the optional ThermoMatch Spectrum Correlation Software may be used to graph spectra.

SPECTRUM SCAN

This feature invokes the screen shown below. It allows scanning of all measurable wavelengths. Before starting this analysis, configure a site and set the logging parameters.

NOTE: If the unit is not configured for scanning with the ThermoMatch Spectrum Correlation Software, menu items 3 – 6 will not appear on the Scanning Lib menu.

Press “1” to scan a user-defined 2 μm section of the filter (from 8.000 μm to 14.000 μm) at long pathlength. This is a peak picker routine that allows the identification of the absorbance characteristics within the defined region. This aids in the development of user calibrations.

Press “2” to perform a peak pick at short pathlength.

Press “3” through “6” to invoke a scan routine. They all scan the fixed bandpass filters and the entire linear variable filter region. Full scan runs a slightly higher quality scan by more signal averaging, and it takes more time. Fast scan provides quicker results at the expense of a slightly noisier signal. These features are optional and can assist in identifying unknown compounds using the ThermoMatch Spectrum Correlation Software, or to establish a spectral profile for future reference. The “L” and the “S” denote the pathlength to be used in the application.

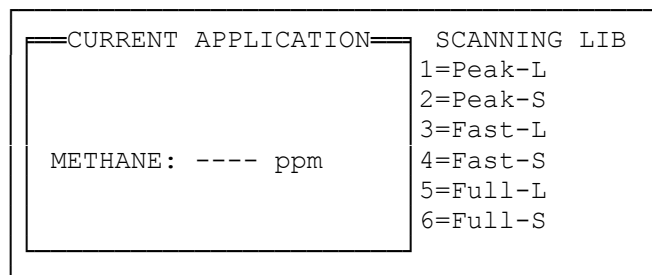

Spectrum Scan Screen

If there was no previous application or if the previous application was not configured for scan, the Choose Log Defaults screen appears. Press “1” to optimize the logging parameters (Log Mode = Single Sample, Log Interval = 1 cycle, and Log Start = Auto), or press “2” to keep the present logging parameters.

<pre>==CURRENT APPLICATION== METHANE: ---- ppm</pre>	<pre>Auto configure logging with auto start and one cycle interval? 1=Yes, reconfig 2=Keep current</pre>
--	---

Choose Log Defaults Screen

The report format provides wavelength position and associated absorbance values. For ease of analysis, these may be graphed using commercial software.

Chapter 7

CONFIGURATION and SETUP

Setup mode customizes the analyzer as shown in Table 7-1.

To access the Setup mode, press 4 (Config/Setup) from the Main Menu. The display presents the Setup Menu, shown below. A summary of the current site, measurement units, and clock reading is shown on the left and the menu of selections on the right.

SUMMARY	SETUP MENU
Unit: Default	1=Calibration
Clock: 01Jan01	2=Preferences
13:30:45	3=Gas unit
	4=Set clock
	5=Analysis

Setup Menu

The contents of each of the five setup menu choices are shown in Table 7-1.

Chapter 7 Configuration and Setup

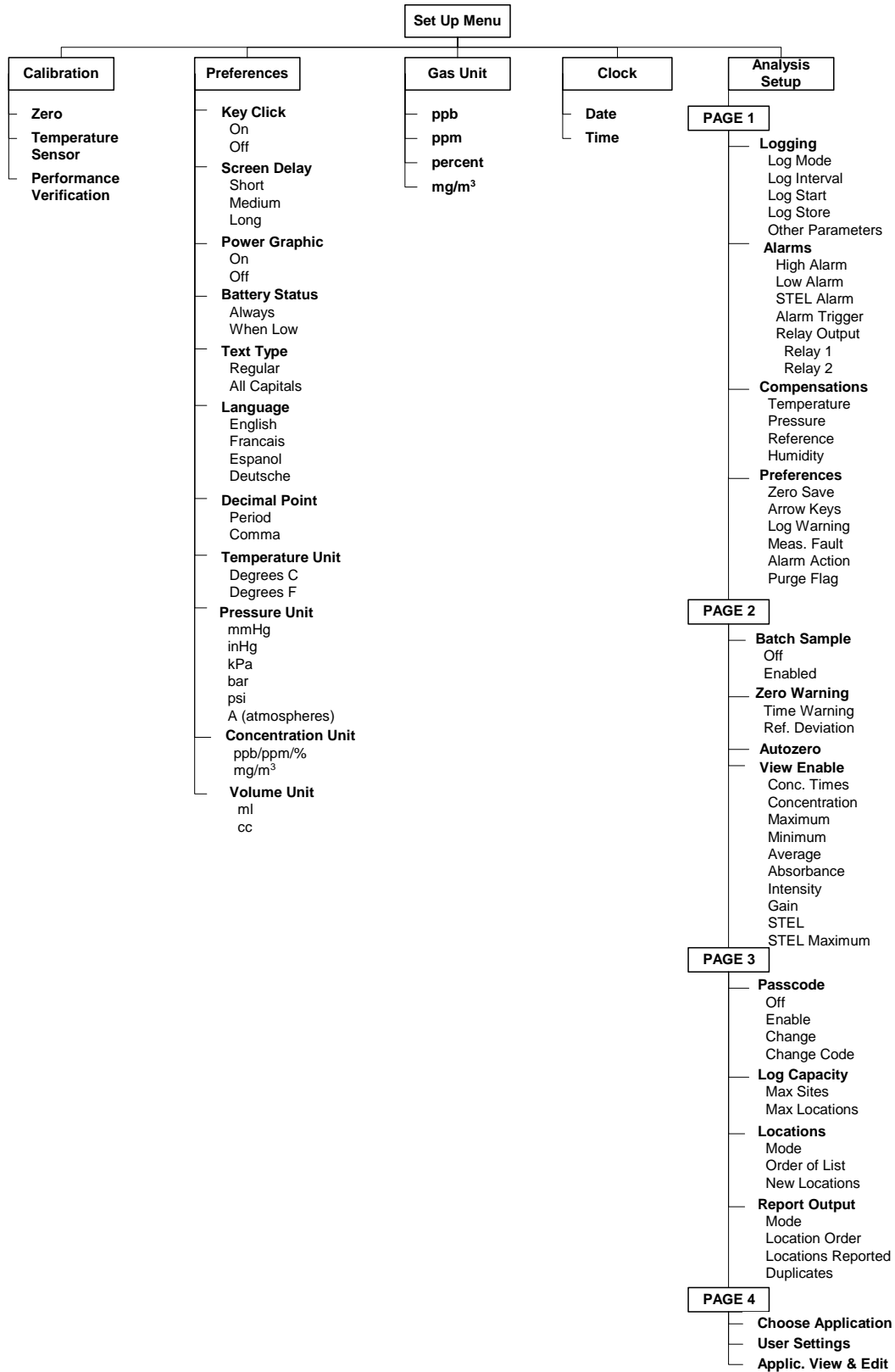
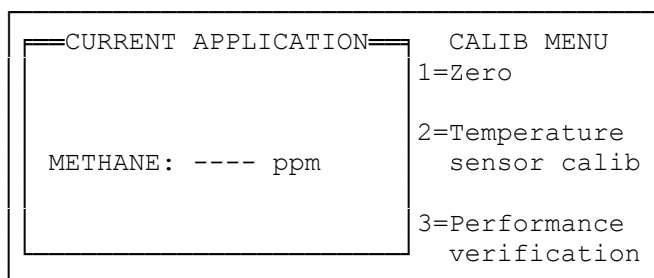

Table 7-1. Setup Menu Content

CALIBRATION

The Calibration mode can be used to check zero, to calibrate the temperature sensor, or load the performance verification application. To access the Calibration mode, press **1** from the Setup Menu. The display presents the Calibration Menu (see Calibration Menu, below). The current application is shown on the left and the menu of selections on the right.



Calibration Menu

Zero

The Zero function allows another opportunity to zero the analyzer. To begin this function, press **1** (Zero). The remainder of the procedure is the same as that explained in Chapter 5, “To Zero the Analyzer.”

Temperature Sensor Calibration

This allows the user to perform an offset calibration should the temperature sensor drift over time. The user should measure the ambient temperature using an external thermometer and enter the value on the screen.

Performance Verification

This loads a multi-gas application that may be used to verify proper performance. Refer to Appendix E for details.

PREFERENCES

The Preference Menus configure various operational features of the analyzer and makes various display selections. To access the Setup Preference Menu, press **2** (Preferences) from the Setup Menu. The current preferences are displayed on the left and the menu of selections on the right (see Setup Preference Menu Page 1, below).

Chapter 7 Configuration and Setup

SUMMARY	PREFERENCE MENU
Key click: On	1=Key click
Screen delay: Medium	2=Screen delay
Power graphic: On	3=Power graphic
Battery status: Always	4=Battery status
Text type: Regular	5=Text type
	⬇ =More

Setup Preference Menu Page 1

Menu Item	Selections
1 = Key click	Turns on or off a feature which produces a beep with each key press: 1 = On and 2 = Off.
2 = Screen delay	Selects the length of time an acknowledgment message appears on the screen: 1 = Short (0.5 seconds), 2 = Medium (1 second), and 3 = Long (2 seconds).
3 = Power graphic	Displays a startup screen graphic when turning the analyzer on: 1 = On and 2 = Off.
4 = Battery status	Selects when to show the battery status symbol on the display: 1 = Always and 2 = When battery is low.
5 = Text type	Selects the text type: 1 = Regular (both upper and lower case) and 2 = All Capitals.

To access the second page of the Setup Preference menu, press the down arrow key. See (see Setup Preference Menu Page 2, below).

SUMMARY	PREFERENCE MENU
Language: English	1=Language
Decimal pt: Period	2=Decimal point
Temp unit: °C	3=Temp unit
Press unit: mmHg	4=Press unit
Conc unit: ppb/ppm/%	5=Conc unit
Volume unit: ml	6=Volume unit
	⬇ =More

Setup Preference Menu Page 2

Menu Item	Selections
1 = Language	Selects the language of the display: 1 = English, 2 = Francais, 3 = Espanol, and 4 = Deutsche
2 = Decimal	Selects the type of decimal point character: 1 = a period (.) and 2 = a comma (,).
3 = Temp unit	Selects the temperature unit: 1 = °C and 2 = °F.
4 = Press unit	Selects the pressure unit: 1 = mmHg, 2 = inHg, 3 = kPa, 4 = bar, 5 = psi, and 6 = A (atmospheres)
5 = Conc unit	Selects the concentration default unit: 1 = ppb/ppm/% and 2 = mg/m ³ .
6 = Vol unit	Selects the liquid volume unit: 1 = ml and 2 = cc.

GAS UNIT

Pressing 3 (Gas unit) from the Setup Menu causes the Unit Gas Selection Menu to be displayed (see Unit Gas Selection menu, below). The current application is displayed on the left and the menu of selections on the right. Choose the gas for which the units are specified. (If there is a single gas application, this display is omitted and the display shown in the right side of Gas Unit menu, shown below, is displayed instead.)

Note: Changing the gas unit from ppm to ppb does not increase the analyzer's sensitivity.

<p>==CURRENT APPLICATION==</p> <p>METHANE: ---- ppm</p> <p>ETHANE: ---- ppm</p> <p>BUTANE: ---- ppb</p> <p>PROPANE: ---- ppm</p> <p>HEXANE: ---- ppm</p> <p>GROUPTWA: ---- %</p>	<p>Select gas:</p> <p>1=METHANE</p> <p>2=ETHANE</p> <p>3=BUTANE</p> <p>4=PROPANE</p> <p>5=HEXANE</p> <p>6=GROUPTWA</p> <p>Enter=All</p>
--	---

Unit Gas Selection Menu

Chapter 7 Configuration and Setup

Next, the Gas Unit Menu is displayed (see Gas Unit menu, below). The current application is displayed on the left and the menu of selections on the right. Choose Select the unit from the menu. Press **ENTER** to set all gases to their default unit.

CURRENT APPLICATION	Select unit:
METHANE: ---- ppm	1=ppb
ETHANE: ---- ppm	2=ppm
BUTANE: ---- ppb	3=percent
PROPANE: ---- ppm	4=mg/m^3
HEXANE: ---- ppm	
GROUPTWA: ---- %	
	Enter=Default

Gas Unit Menu

If one of the above units is selected the user is asked to further specify how long the selected units should be used. 1 = Always and 2 = Until another application is selected. The display then summarizes the selections and indicates **ACCEPTED**.

CLOCK

Selecting 4 = Clock from the Setup Menu causes the Clock Menu to be displayed (see Clock Menu, below). The current clock reading is displayed on the left and a place to enter the new date on the right. See Chapter 4, "Entering Alpha Characters" for entering the letters of the month. Pressing **ENTER** to accept the new date changes the screen to a similar display to change the time. After setting the time and pressing **ENTER**, the display responds "-ACCEPTED-."

CLOCK	Enter new date:
Clock: 04Jan01 13:30:46	11Jan01
	Δ=Backsp ▽ =Next
	Enter=Accept

Clock Menu

ANALYSIS

Analysis Setup is done from four menus. The menus are shown here and are discussed in depth in the following sections.

<p style="text-align: center;">—SUMMARY—</p> <p>Logging—Single Sample └ 10 Seconds</p> <p>Alarms—√High _STEL └ _Low</p> <p style="text-align: center;">—Compensations—</p> <p>_Temp _Pres _Ref _H2O</p>	<p>ANALYSIS SETUP</p> <p>1=Logging</p> <p>2=Alarms</p> <p>3=Compensations</p> <p>4=Preferences</p> <p style="text-align: right;">△=More</p>
---	---

Analysis Setup Menu Page 1

<p style="text-align: center;">—SUMMARY—</p> <p>_Batch sampling</p> <p>_Zero warning</p> <p>_Autozero</p> <p style="text-align: center;">—Data Views—</p> <p>√Conc _Max _Min _Avg _STEL _Absb _Intn _Gain</p>	<p>ANALYSIS SETUP</p> <p>1=Batch sample</p> <p>2=Zero warning</p> <p>3=Autozero</p> <p>4=View enable</p> <p style="text-align: right;">△=More</p>
--	---

Analysis Setup Menu Page 2

<p style="text-align: center;">—SUMMARY—</p> <p>Passcode: Off</p> <p style="text-align: center;">—</p> <p>Capacity: 50/200</p> <p>Locations: Off</p> <p>Reprt Out: As logged</p>	<p>ANALYSIS SETUP</p> <p>1=Passcode</p> <p>2=Log capacity</p> <p>3=Location list</p> <p>4=Report output</p> <p style="text-align: right;">△=More</p>
--	--

Analysis Setup Menu Page 3

<p style="text-align: center;">—SUMMARY—</p> <p>Applic: METHANE</p>	<p>APPLIC SETUP</p> <p>1=Choose applic</p> <p>2=Applic view and edit</p> <p>3=User settings</p> <p style="text-align: right;">△=More</p>
---	--

Analysis Setup Menu Page 4

ANALYSIS SETUP PAGE 1

Pressing 5 (Analysis) from the Setup Menu causes the display to ask for the passcode if the analyzer is configured to be passcode-protected. If the passcode is correct, the first of four Analysis Setup Menus is displayed (see Analysis Setup Menu Page 1, above). The current application setup summary is displayed on the left and the menu of selections on the right. In the summary, the Logging mode is described as: Off, Single sample (single sample per logging trigger), Continuous (continuous sampling per logging trigger), or Custom (customized logging configuration); the Alarm state is indicated as High, Low, or STEL; and the compensations indicated as Temperature, Pressure, Reference, and Humidity.

To move to one of the other three Analysis Setup menus, press the up or down arrow keys one or more times. Press **ESC** to return to the Setup Menu.

In the summary shown in the Analysis Setup Menu Page 1, the Logging mode is shown as Single Sample and the Logging interval is set at 10 seconds (the unit counts down 10 seconds after the trigger). The Alarm setpoint is triggered on the High level. All Compensations are turned off.

Logging

To change the logging characteristics, press 1 (Logging) from the Analysis Setup Menu Page 1. The Log Menu is displayed.

LOG SUMMARY	LOG MENU
Mode: Single Sample	1=Log mode
Interval: 5 seconds	2=Log interval
Start: Manual	3=Log start
	4=Log store
Store: _OnAlrmOnly _STEL	5=Other parms
√Mx _Min _Avg _Abs _Tmp	

Log Menu

The summary of the present log configuration is shown on the left. The selections at the bottom of the display indicate the type of log: Mx = maximum, Min = minimum, Avg = average, Abs = absorbance, and Tmp = temperature. In the example given in Log Menu, above, the log will only store the Maximum value concentration in the 5-second countdown interval.

Log Mode

To set the Log Mode, press **1** (Log mode) from the Log Menu. Then press **1** to turn off the logging feature, **2** to specify a single sample per logging trigger, or **3** to specify continuous sampling per logging trigger. The display responds "-ACCEPTED-."

Single Sample Logging

Use this mode to log the same gas(es) at a variety of locations. For example, use single sample logging if performing leak detection at a variety of locations. This setting only logs one point. Additional points are logged by pressing the "1=Log" during analysis.

Continuous Sample Logging

Use this mode to monitor one location for an extended period of time. For example, use continuous sample logging if monitoring an area where technicians are working for a period of four hours.

It is highly recommended that the reference, temperature, and humidity compensations should be enabled if continuous sample logging is used. This is because the analyzer can experience drift from internal and environmental factors. The above compensations minimize those drift sources to produce a more stable baseline.

Finally, since the SapphIRe analyzer is a portable unit, it is not designed to operate continuously for long periods of time. Periods of analysis beyond 24 hours can result in premature replacement of some components.

Log Interval

In single sample mode, the log interval is the countdown time after the logging trigger; in continuous mode, it is the frequency of logging. To enter Log Interval, press **2** (Log interval) from the Log Menu. It can be entered as 1 to 999 seconds, 1 to 999 minutes, or 1 to 999 cycles. The numeric field entry is keyed in; the units are selected with the down arrow key. If the Log Mode is continuous there are three other alternatives. To view these, press the period (.) key. Then in the next menu, select **1** to use the factory set interval, **2** to log a value at the end of each measurement cycle, or **3** to use the smallest interval in seconds that does not overflow the logging memory within eight hours. The display responds "-ACCEPTED-."

Note: Too small an interval is chosen if in a multi-gas analysis mode or compensations enabled (for example, 10 seconds) the analyzer displays an error message. This is because the analyzer only provides one new set of concentration readings at the end of the cycle which, depending on the number of wavelengths in the application and the sampling duration, could be anywhere from approximately 30 seconds to a maximum of approximately 120 seconds.

Log Start

Log Start chooses the trigger mechanism to begin logging data. Use the Manual start, the Auto start to have logging start automatically upon entering Analysis, or set the start time and the duration for a Timed start. To access this parameter, press **3** (Log start) from the Log Menu. Then press **1** to specify a Manual start, **2** to specify an Auto start, or **3** to specify a Timed log start. If a Timed log start is selected, the next display prompts entering the time to start logging. Enter the time in a HH:MM format. Specify the hours from 00 to 23 (24 hour clock) and the minutes from 00 to 59. Upon a valid entry, the next display prompts entering a timed log duration. It can be entered as 1 to 999 seconds or minutes. The numeric field entry is keyed in; the units are selected with the down arrow key. The display responds "-ACCEPTED-."

Log Store

Log Store selects the data to store for the log. To access this parameter, press **4** (Log store) from the Log Menu. Then press **1** to specify maximum value, **2** for minimum, **3** for average, **4** for absorbance, **5** for STEL, **6** for temperature, and **7** for on alarm only.

Note: Option 7 only stores data when an alarm is activated.

When finished, press **ENTER** to set these selections. The display indicates that the entries are ACCEPTED.

When in the single sample mode or in the continuous sample mode for a single gas analysis, the interval can be set, for example, at 10 seconds. The analyzer measures data at a rate of two points per second. Thus, in the 10 second period of this example, there will be 20 data points from which to choose. It may be useful to store the Mx, Min, and Avg of those 20 values. At the end of the interval, the analyzer discards all other data points. Memory space is impacted only by those entries that are stored.

Note: If data is stored for absorbance, STEL or temperature modifications to the standard report definition are required (refer to Chapter 14, “*Custom Report Formatting*”) to retrieve the data.

Other Parameters

In the Continuous Sample Mode, the analyzer is placed in Auto Save and Auto Repeat Mode. This means that the analyzer automatically stores the log without user intervention and continue logging at the defined logging interval.

In Single Sample Mode, the Auto Save and Auto Report parameters are disabled. This means that in order to save a log and then continue logging, it must be acknowledged. The Auto Save and Auto Repeat in Single Sample Mode can be changed to the default log options. To do this, press **5** (Other parms) from the Log Menu. Then press **1** to enable Auto Repeat and **2** to enable Auto Save. When finished, press **ENTER** to set these selections. The display responds "-ACCEPTED-."

```

=====LOG SUMMARY=====
  Mode: Single sample
Interval: 10 seconds
  Start: Manual
                                     _Auto repeat
                                     √Auto save
Store: _OnAlrmOnly _STEL
√Mx √Min √Avg _Abs _Tmp
                                     -ACCEPTED-
    
```

Other Parameters Menu

Alarms

To configure the state of the alarms, press **2** (Alarms) from the Analysis Setup Menu Page 1. The Alarm Menu is displayed (see Alarm menu, below). The current alarm summary is displayed on the left and the menu of selections on the right. In the summary, the alarms may be described as Off, Enabled, or Latched.

Note:

1. A Low alarm is activated by a reading above the lower of two alarm setpoints; a high alarm is activated by a reading above the higher of the two alarm setpoints.
2. To configure the High, Low, and STEL alarm setpoints, see Alarms, below.

```

=====ALARM SUMMARY=====
High alarm: Enabled
Low alarm: Enabled
STEL alarm: Latched
                                     ALARM MENU
                                     1=High alarm
                                     2=Low alarm
                                     3=STEL alarm
                                     _____
√Conc Trig   √Relay 1
√Avg Trig    √Relay 2
                                     4=Alarm trigger
                                     5=Relay output
                                     6=Geiger countr
    
```

Alarm Menu

Chapter 7 Configuration and Setup

Note: The “Latched” alarm state only applies to the alarm relay. To make the audible alarm work as a latching alarm, set the Alarm action to ErrScrn in Analysis Preferences (see page 7-15).

Press 1 from the Alarm Menu to set the state of the High alarm, 2 for the Low alarm and 3 for the STEL alarm. At the next display, specify the state of that alarm by pressing 1 for Off, 2 for Enabled, or 3 for Latched. The display responds "-ACCEPTED-."

```
=====ALARM SUMMARY=====
High alarm: Off
Low alarm: Off
STEL alarm: Off

_Conc Trig   _Relay 1
_Avg Trig    _Relay 2

Select high
alarm state:

Off

1=Off
2=Enabled
3=Latched
```

Alarm State Menu

An Enabled alarm is triggered when the measurement exceeds a preset value. When the measurement falls below the setpoint, the alarm is extinguished. A Latched alarm also is triggered when the measurement exceeds a preset value. However, the alarm is only extinguished when acknowledged via the Control Menu.

Warning: Intrinsically safe models require special actions with respect to the following section. Refer to Appendix B for descriptions of these actions.

Press 4 from the Alarm Menu to specify the error and relay triggers. At the Alarm Trigger display, press 1 to specify alarms related to current concentration and 2 to specify alarms related to average concentration.

Press 5 from the Alarm Menu to select an alarm relay. At the Alarm Relay display, press 1 to specify Relay 1, 2 to specify Relay 2, and **ENTER** to specify All relays. If the current application is multi-gas, a Select Gas display selects the gas that is associated with the selection. If the relay setting is associated with more than one gas, select all gases by pressing **ENTER**. The next display asks specifies how to activate the relay. Press 1 to activate it on a High alarm, 2 for a Low alarm, 3 for a STEL alarm, 4 for No alarm (deactivate the relay), and 5 for All alarms. The display responds "-ACCEPTED-." The relays are Form C, SPDT rated at 24 V dc, 0.25 A.

Note: The relays must be turned on in the Control menu

Compensation

To specify analysis compensations, press **3** (Compensations) from the Analysis Setup Menu 1. The Analysis Compensations Menu is displayed. Press **1** to specify Temperature compensation, **2** for Pressure, **3** for Reference, and **4** for Humidity. When finished, press **ENTER** to accept these selections. The display responds "-ACCEPTED-."

Invoking the reference and/or humidity compensation will increase the cycle time. Batch sampling mode should be used for these compensations.

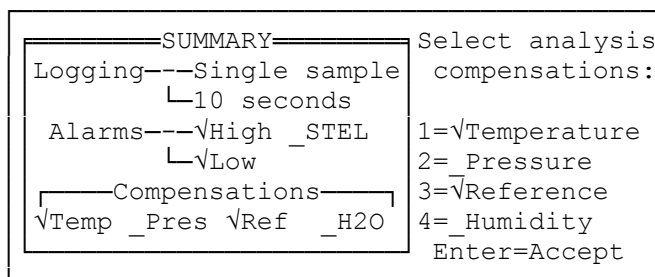

Analysis Compensations Menu

Temperature Compensation

All measurements are susceptible to changes in ambient temperature. In order to minimize these changes, a temperature sensor has been installed in the analyzer to measure the temperature. The temperature is then compared to the temperature at the zero point and a correction in the concentration value is made.

Pressure Compensation

At higher elevations, the ambient pressure is lower than at sea level. These changes can affect the concentration value. Thus, at higher altitudes, the analyzer displays lower readings than at sea level. To correct for this difference, measure the ambient pressure with an external device and enter this pressure value into the analyzer. Do this during the zero procedure or as part of Application setup. The SapphIRe analyzer then corrects for this difference by applying a correction factor.

Reference Compensation

All electronic systems experience drift due to a variety of factors including degradation of parts, ambient conditions, and inherent electronic noise. To minimize these factors, the SapphIRe analyzer can apply reference wavelength compensation. Reference Compensation is performed automatically when enabled and when supported by the application (all standard library applications are supported). The analyzer makes a measurement of a gas as its analytical wavelength and then moves to a reference wavelength specified by Thermo Fisher Scientific or by the user (see Reference Wavelength, below).

Chapter 7 Configuration and Setup

The reference wavelength is chosen based on the analytical wavelength and must be chosen at a wavelength where other gases do not absorb IR energy. The default wavelength of 4.004 microns should be used if the presence of other gases is not certain.

Once the analyzer has measured the signal at the reference wavelength, the value is applied to the analytical wavelength and a correction in its value is made. The process of switching between the analytical wavelength and reference wavelength is continuously repeated.

Use of the reference wavelength compensation can greatly improve the stability of the SapphIRe analyzer in long term and short term monitoring applications. Choosing reference wavelength compensation slows down the cycle time of the analyzer.

Figure 7-1 shows that reference compensation greatly improves the ability of the analyzer to remain stable over extended periods of time. It is still important, however, to let the instrument warm up for at least 10 minutes prior to beginning an analysis.

The information in Figure 7-1 was generated by enabling a reference compensation at the default wavelength setting of 4.004 microns. The data was logged at one minute intervals in the continuous mode. For graphing purposes, the text data was converted into an Excel spread sheet using the Data Parse option.

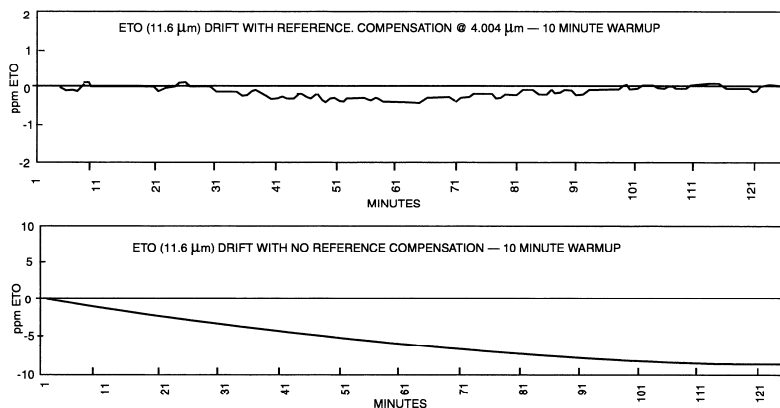

Figure 7-1. Effect of Reference Compensation

Humidity Compensation

Changes in ambient humidity can significantly affect the accuracy of the gas concentration. When humidity levels change from the zero time, the gas concentration can either rise or fall as those ambient levels rise and fall, respectively. For example, if the analyzer is zeroed in a 30% RH area and then taken to an 80% RH area, the reading for the gas will most likely rise. The level of fluctuation is gas and wavelength dependent. Optimal compensation is accomplished if the change in relative humidity is $\pm 20\%$. If there is a larger change, rezeroing the instrument is recommended. To

compensate for this effect, the analyzer employs an analysis wavelength which is responsive mainly to water vapor. Intensity changes at this and the reference wavelength may be used to correct for changes in sample absorbance due to variable water vapor levels after zeroing. The humidity compensation routine should be applied when the analyzer is being used as a continuous monitor since humidity levels can vary over the duration of the sampling period. As with reference compensation, utilizing the humidity compensation algorithm increases the cycle time since water vapor is an additional wavelength point to be collected. The humidity compensation must be enabled for the correction to take place. When humidity is activated, the batch mode should be enabled. This insures that the compensation of the analytical wavelengths is properly performed as the sample remains consistent.

This compensation should not be invoked if it is known in advance that the sample air is very, very dry (<10% RH at reference conditions).

Analysis Preferences

The Analysis Preference menu configures various operational features of the analyzer. To access the Preference Menu, press **4** (Preferences) from the Analysis Setup Menu 1. The current preferences are displayed on the left and the menu of selection on the right.

SUMMARY	PREFERENCE MENU
Zero save: Manual	1=Zero save
Arrow keys: Location	2=Arrow keys
Log warning: Off	3=Log warning
Fault action: Beep	4=Fault action
Alarm action: ErrScrn	5=Alarm action
Purge flag: Enabled	6=Purge flag

Analysis Preference Menu

Chapter 7 Configuration and Setup

Menu Item	Selections
1 = Zero save	Selects the zero save mode: 1 = Auto and 2 = Manual. In Auto Mode, when a zero has been performed, a valid zero is automatically saved and the next prompt displayed. In Manual Mode, when a zero has been performed, there is a prompt that the zero is valid and instructed to Save or Repeat Zero (see Chapter 5, Save Zero Display screen).
2 = Arrow keys	Data View enables viewing the data, described in Chapter 5, "To Begin Analysis". by using the arrow keys. Pressing 1 = Data View, Pressing 2 = Locations. If this is chosen, the various data can still be viewed by using the 6 and 9 keys as arrow keys.
3 = Log Warning	Automatically logs if and when an alarm or fault or both occurs. Press 1 (Off) to turn off this feature, 2 (On) to log at an alarm or a fault, 3 (On alarm only) to log at an alarm, and 4 (On fault only) to log at a fault.
4 = Fault action	Specifies the type of notification received if a fault occurs. Press 1 (None) if only a symbol should be displayed, 2 (Beep) if an audible signal is also desired, and 3 (Error Screen) if an error screen is desired in addition to the symbol and beep.
5 = Alarm action	Specifies the type of notification received, provide a concentration alarm occurs. Selections are the same as "Fault Action."
6 = Purge flag	Enables receiving a "P" display indicator if a purge is not completed. Press 1 (Off) to turn off this feature and 2 (Enabled) to enable it.

ANALYSIS SETUP PAGE 2

To continue with the analysis setup, press the down arrow key in the Analysis Setup Menu Page 1. The Analysis Setup Menu Page 2, shown below, is displayed.

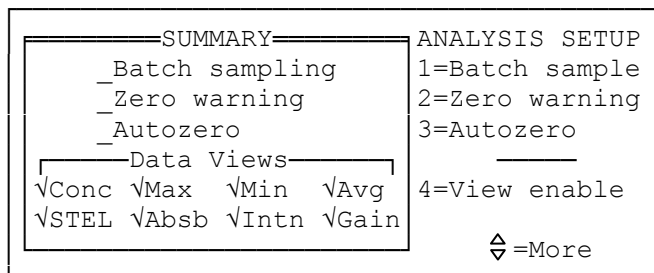

Analysis Setup Page 2 Menu

The current application setup summary is displayed on the left and the menu of selections on the right.

Batch Sample

Batch sampling is typically employed in multi-gas applications or spectral scanning because the sample should be static when measuring each wavelength. That is, the concentration in the gas cell should not change when measuring the first wavelength compared to the last wavelength. This is critical because the concentration of the first gas can be related to the compensation factor of the last gas. If those ratios change because the sample has changed, the results can be incorrect.

In the batch sampling process, the analyzer internal pump pulls a sample into the gas cell for the application defined batch purge time (typically 20 seconds), the pump is shut down, and each component is analyzed at its defined wavelength. After the data is displayed, the cycle is repeated.

To turn the batch sampling feature on or off, press **3** (Batch sample) from the second Analysis Setup Menu. Upon presentation of the next display, press **1** to turn the batch sampling feature off or **2** to enable the feature. The display responds "-ACCEPTED-." When using Reference Compensation in Single Sample Mode, Batch Sample may be turned off.

Zero Warning

The Zero Warning feature reminds about rezeroing the analyzer in a set length of time or when the absorbance drifts from the reference by an established amount. To access this feature, press **2** (Zero warning) from the Analysis Setup Menu Page 2. Upon presentation of the next display, press **1** to set a time warning or **2** to select a reference deviation warning.

Chapter 7 Configuration and Setup

If 1 is pressed, the next display requires entering the zero warning time interval. This can be set from 0 to 999 minutes or hours. The numeric field entry is keyed in; the units are selected with the down arrow key. The display responds "-ACCEPTED-."

If 2 is pressed, the next display requires entering the reference absorbance drift. This can be a number from 0 to 9.9999. The display responds "-ACCEPTED-." A typical deviation is 0.015 absorbance units.

Note: If drift level is not zero and the reference wavelength is not measured, there is a warning that the reference wavelength must be measured.

Autozero

This feature is not available at the present time.

View Enable

The View Enable parameter enables specifying which types of analysis data may be viewed. To access this parameter, press **4** (View Enable) from the Analysis Setup Menu Page 2. Upon presentation of the next display, press **0** to specify time, **1** for Concentration, **2** for Maximum, **3** for Minimum, **4** for Average, **5** for Absorbance, **6** for Intensity, **7** for Intensity gain, **8** for STEL, and **9** for STEL maximum. When finished, press **ENTER** to set these selections. The display responds "-ACCEPTED-."

In the summary, data views are marked active (√) as follows:

Conc:	Concentration view enabled
Max:	Concentration maximum view enabled
Min:	Concentration minimum view enabled
Avg:	Concentration average view enabled
STEL:	Concentration STEL view enabled
Absb:	Absorbance view enabled
Intn:	Intensity view enabled
Gain:	Intensity gain view enabled
STEL Max:	Concentration STEL maximum view enabled*
Time:	Maximum, Minimum, and/or STEL Maximum time views enabled*
*STEL Max and Time data views are not shown in the above screen. However, they are displayed when View Enable is accessed.	

Note: Absorbance, Intensity, and Intensity Gain views are primarily used by factory personnel.

ANALYSIS SETUP PAGE 3

To continue with the analysis setup, press the down arrow key from the second Analysis Setup Menu. The third Analysis Setup Menu, shown below, is displayed.

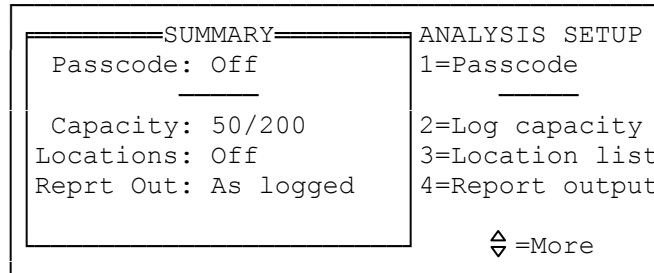

Analysis Setup Page 3 Menu

The current application setup summary is displayed on the left and the menu of selections on the right.

Passcode

To turn the passcode on or off or to change the passcode, press **1** (Passcode) from the third Analysis Setup Menu. The Passcode Menu is displayed. Press **1** to turn the passcode feature off, **2** to enable the feature, or **3** to change the code.

If **3** is pressed, the display requires entering the new passcode. The passcode can contain from 1 to 10 digits. After entering the new passcode, press the **ENTER** key. If the password is accepted, enter the password again to verify it. If this is also valid, the display responds "-ACCEPTED-."

Log Capacity

To configure the log capacity, press **2** (Log capacity) from the third Analysis Setup Menu. The Log Capacity Menu is displayed. Press **1** to specify the maximum number of sites and **2** to specify the maximum number of locations per site. The maximum number of sites can be from 1 to 50 and the maximum number of locations per site, from 1 to 200.

Locations

To configure the locations, press **3** (Location List) from the Analysis Setup Page 3. The Location Menu, shown below, is displayed.

LOCATION SUMMARY	LOCATION MENU
Mode: Enabled	1=Mode
Ordering: As entered	2=Order of list
Insert: Alphabetical	3=How to insert new locations into list

Location Menu

Press **1** to select the location mode. At the next display, press **1** to turn the location function Off or press **2** to Enable the function. The display responds "-ACCEPTED-." To gain access to the list of stored locations or to add locations during logging, enable the Location Mode. Enabling the Location Mode results in item 3, 4, and 5 being added to the analysis menu during run mode.

Press **2** to configure how the location list is sorted. At the next display, press **1** to sort as entered or press **2** to sort alphabetically. The display responds "-ACCEPTED-."

Press **3** to specify where to insert a new location. At the next display, press **1** to select Not allowed, **2** to insert alphabetically, **3** to insert at list end, or **4** to insert above current location. The display responds "-ACCEPTED-." Refer to Chapter 8, "Site Info" for more information about sites and locations.

Report Output

The Report Output parameter configures certain features of the report output. To access this feature, press **4** from the third Analysis Setup Menu. Upon presentation of the report output display, press **1** to select the report output mode, **2** to select the report location order, **3** to select the locations reported, or **4** to select if duplicates are to be reported.

If **1** is pressed to select the report output mode, press **1** again to choose the "As Logged" mode or **2** to choose the "By Location" mode.

Note: If **1** is selected and data was not logged to locations, no site report data will be output.

If **2** is pressed to select the report location order, press **1** to choose "As Entered" or **2** to choose "Alphabetical."

If **3** is pressed to select the locations reported, press **1** to choose “All Locations” or **2** to choose “Only Logged” locations.

If **4** is pressed to select if duplicates are to be reported, press **1** to choose “Duplicates” or **2** to choose “No Duplicates.”

ANALYSIS SETUP PAGE 4

This menu, shown below, differs from the three other Analysis Setup Menus in that it is used to set up a specific application. It is accessed by pressing the down arrow key from Analysis Setup Page 3 menu or the up arrow key from Analysis Setup Page 1 menu.

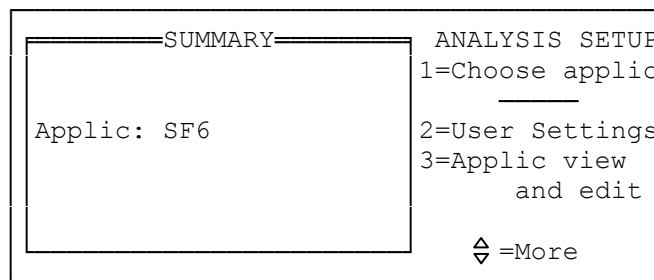

Analysis Setup Menu Page 4

Choose Application

If the application shown on the left side of the display is not the application that is to be set up, press **1** (Choose applic). Refer to changing applications at the beginning of this chapter for instructions on how to choose an application.

User Settings

User Settings modify the parameters of the selected application that do not impact application performance. This involves selecting the gas if it is a multi-gas application and then configuring the gas unit, high alarm, low alarm, STEL alarm, and STEL time for any application. A flow chart of the configuration is shown in the User Settings flow chart, below.

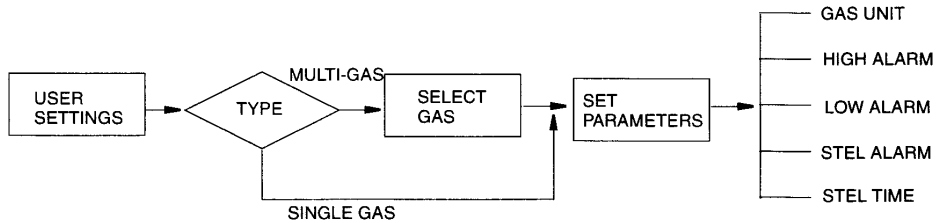
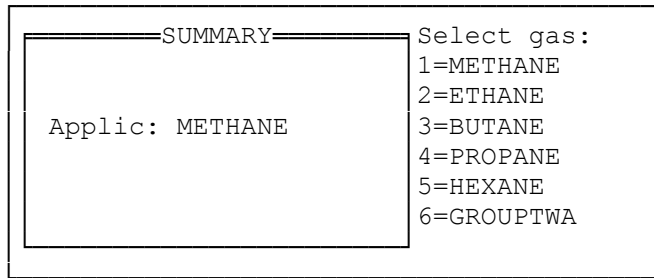

Figure 7-2. User Settings Flow Chart

Note: These are the only parameters that may be changed in standard library applications.

To access this function, press **2** (User settings) from the Application Setup Menu. If it is a multi-gas application, the Select Gas Menu is displayed (see Select Gas menu, below). If it is a single gas application, the Set Parameters Menu is displayed (see Set Parameters menu, below). If it is a multi-gas application, when one of the gases listed in the Select Gas Menu is selected, the display proceeds to the Set Parameters Menu.



Select Gas Menu

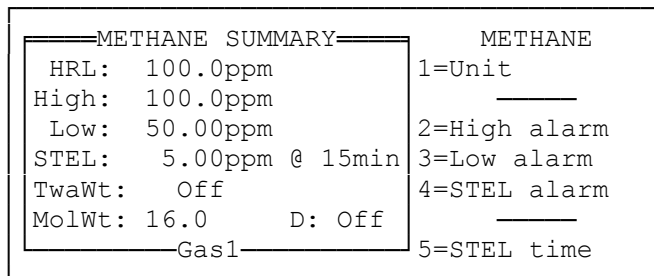

Set Parameters Menu

Unit

To select a unit for the application, press **1** from the Set Parameters Menu. The Gas Unit Selection Menu is displayed. The last unit configured is shown on the display. If this is the unit of the present application, press **ESC**. The display returns to the Application Setup Menu. To change the unit, press **1**. The Gas Unit Selection Menu is displayed. Select the unit for the application. The display responds "-ACCEPTED-" and then returns to the Analysis Setup Menu Page 4.

METHANE SUMMARY		Select
HRL: 100.0ppm		gas unit:
High: 100.0ppm		ppm
Low: 50.00ppm		1=ppb
STEL: 5.00ppm @ 15min		2=ppm
TwaWt: Off		3=Percent
MolWt: 16.0	D: Off	
Gas1		

Gas Unit Menu

The following definitions apply to the Gas Unit menu, Alarm Level menu, Alarm Level Enter menu, and the STEL Time Select menu:

- HRL is the high range limit.
- High is the high level alarm setpoint.
- Low is the low level alarm setpoint.
- STEL is the Short Term Exposure Limit setpoint.
- TwaWt is the group time weighted average factor. Many times when several compounds are present in an area, the combined effect of the gases needs to be considered for industrial hygiene purposes. For example, two gases (Gas A with a TWA of 5 ppm and Gas B with a TWA of 10 ppm), are each below the TWA value for the 8-hour period. However, when both gases are present, it is important to report the combined effect. This is sometimes referred to as a synergistic TWA. The factor that is typically applied to each gas is 1/TWA. So for this example, the factor for Gas A is 1/5 and for Gas B is 1/10. In the calculation of the Group TWA, the instantaneous concentration is multiplied by the factor. Therefore, if Gas A has a concentration of 3 and Gas B, a concentration of 7, the Group TWA is:

$$(3)\left(\frac{1}{5}\right) + (7)\left(\frac{1}{10}\right) = 1.3$$

- MOLWT is the molecular weight of the gas, and is used for conversion to mg/m³.
- D is the density.

Alarms

To set a high, low, or STEL alarm level for the application, press **2**, **3**, or **4** respectively from the Set Parameters Menu. The appropriate Alarm Level Menu is displayed (see Alarm Level menu, below). The last alarm level configured for that alarm is shown on the display. If this is the alarm level for the present application, press **ESC**. The display returns to the Application Setup Menu.

METHANE SUMMARY		Application
HRL: 100.0ppm		gas high alarm:
High: 100.0ppm		
Low: 50.00ppm		500.0ppm
STEL: 5.00ppm @ 15min		
TwaWt: Off		
MolWt: 16.0	D: Off	1=Change
Gas1		△=Prev ▽=Next

Alarm Level Menu

To change the alarm level, press **1**. The Alarm Level Enter Menu is displayed (see Alarm Level Enter menu, below). Key in the desired value and press **ENTER**. If the entry was a valid one, the display responds "-ACCEPTED-" and then return to the Application Setup Menu.

Note: A Low alarm is an alarm activated by a reading above the lower of two alarm setpoints; a high alarm is an alarm activated by a reading above the higher of the two alarm setpoints. Either, or both, alarms may be selected.

METHANE SUMMARY		Enter value for
HRL: 100.0ppm		gas high alarm:
High: 100.0ppm		
Low: 50.00ppm		25 ppm
STEL: 5.00ppm @ 15min		(Zero=Off)
TwaWt: Off		
MolWt: 16.0	D: Off	△ =Backspace
Gas1		Enter=Accept

Alarm Level Enter Menu

STEL Time

To set a time interval for the application STEL alarm, press **5** from the Set Parameters Menu. The STEL Time Menu is displayed. The last time interval configured is shown on the display. If this is the time interval for the present application, press **ESC**. The display returns to the Application Setup Menu. To change the time interval, press **1**. The STEL Time Select Menu is displayed (see STEL Time Select menu, below) Select the time interval for the application (Off, 5, 10, or 15 minutes). The display responds "-ACCEPTED-" and then return to the Application Setup Menu.

METHANE SUMMARY		Select
HRL: 100.0ppm		gas STEL time:
High: 100.0ppm		15 minutes
Low: 50.00ppm		
STEL: 5.00ppm @ 15min		1=Off 2=5 min
TwaWt: Off		3=10 minutes
MolWt: 16.0	D: Off	4=15 minutes
Gas1		

STEL Time Select Menu

APPLICATION VIEW AND EDIT

Application View and Edit allows a more extensive view and edit procedure for the currently selected application. A flow chart of the configuration is shown in the Application View and Edit Flow Chart, below.

Note: Fixed library applications cannot be modified.

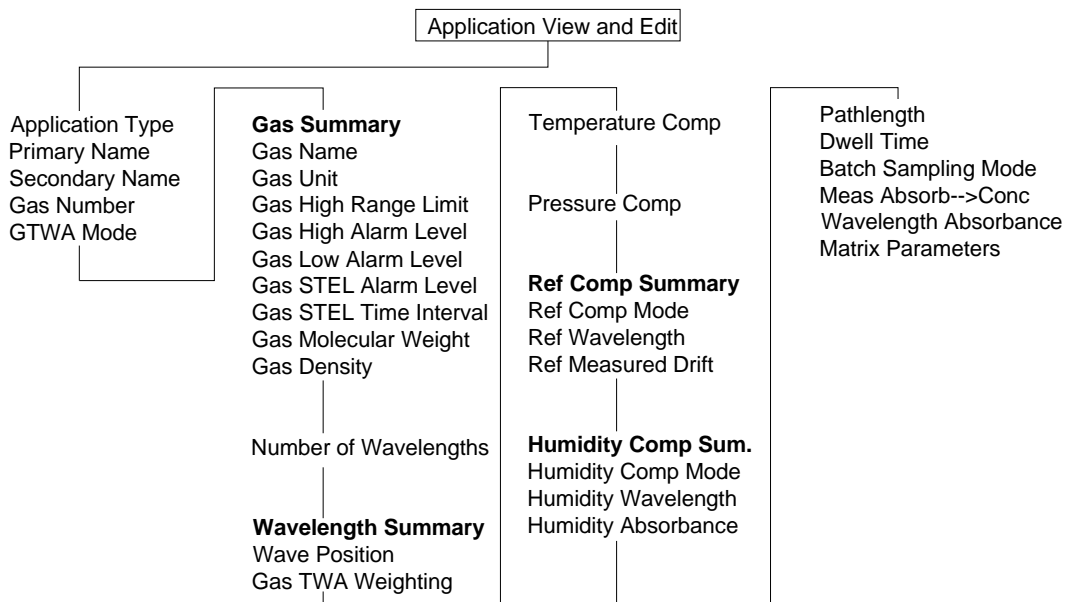

Figure 7-3. Application View and Edit Flow Chart

Caution: Only Gas Unit, Gas High Alarm Level, Gas Low Alarm Level, Gas STEL Alarm Level, and Gas STEL Time Interval can be changed for compounds in the standard library.

To access this function, press **3** (Applic view and edit) from the Analysis Setup Menu Page 4, above. The Primary Name Display, the first of many parameter displays, appears.

Application Type

The Type is the type of the application (single gas, multi-gas, or scanning). The Application Type cannot be changed.

Primary Name

The Primary Name is the name of the application being monitored. The last application configured is shown on the display. If this is the present application, press **ENTER**. The display changes to the next parameter to be configured, Secondary name. To change the name, press **1**. The Primary Name Enter Display appears. Key in the desired name and press **ENTER**. If the entry is valid, the display responds "-ACCEPTED-" and then changes to the next parameter to be configured, Secondary name.

Secondary Name

The Secondary Name is the name defined for enhanced version applications. The last name configured is shown on the display. If this is the name wanted for the present application, press **ENTER**. The display changes to the next parameter to be configured. Press **1** to change the name. The Secondary Name Enter Display appears. Key in the desired name and press **ENTER**. If the entry is valid, the display responds "-ACCEPTED-" and then changes to the next parameter to be configured.

Gas Count

The Gas Count is the number of gases (1 through 10) for the application. The last number configured is shown on the display. If this is the desired number for the present application, press **ENTER**. The display changes to the next parameter to be configured. To change the number, press **1**. The Gas Count Enter Display appears. Key in the desired number (1 through 10) and press **ENTER**. If the entry is valid, the display responds "-ACCEPTED" and then changes to the next parameter to be configured.

Group TWA

Group TWA enables setting the multi-gas group TWA mode off or on. The last mode condition configured is shown on the display. If this is the type of the present application, press **ENTER**. The display changes to the Gas Summary. To change the mode condition, press **1**. The Group TWA Selection Display appears. Select the mode for the application. The display responds "-ACCEPTED-" and then changes to the Gas Summary.

Gas Summary

The Gas Summary allows reviewing the values of the gas parameters for each gas in the application (see Gas Summary Display, below). Move from one gas to the next with the arrow keys. To accept the parameters for each gas, press **ENTER**. When the last gas is reached, the display jumps to the Wave Number Display. To change the parameters in the Gas Summary for a gas, press **1**. The Gas Name Display is presented.

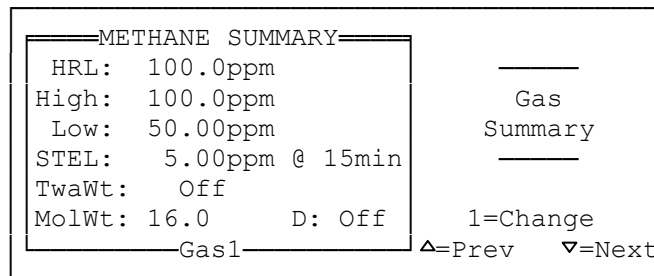

Gas Summary Display

Gas Name

The Gas Name is the name of the gas for the application. This name is displayed during analysis. The last name configured is shown on the display. If this is the desired gas for the present application, press **ENTER**. The display changes to the next parameter to be configured. To change the name, press **1**. The Gas Name Enter Display appears. Key in the desired name and press **ENTER**. If the entry is valid, the display responds "-ACCEPTED-" and then changes to the next parameter to be configured.

Gas Unit

The Gas Unit is the concentration unit for the application (ppb, ppm, percent, or mg/m³). The last unit configured is shown on the display. If this is the unit of the present application, press **ENTER**. The display changes to the next parameter to be configured. To change the unit, press **1**. The Unit Selection Display appears. Select the unit for the application. The display responds "-ACCEPTED-" and then changes to the next parameter to be configured.

Gas High Range Limit

The Gas High Range Limit (HRL) is the high range limit of the gas for the application. The last limit configured is shown on the display. If this is the limit for the present application, press **ENTER**. The display changes to the next parameter to be configured. Press **1** to change the limit. The High Range Limit Enter Display appears. Key in the desired limit and press **ENTER**. If the entry is valid, the display responds "-ACCEPTED-" and then changes to the next parameter to be configured.

Note: The instrument continues to display readings above this high range value, but these readings will not be accurate, and a high range limit error flag will be displayed. Changing this value might require changes to the application's linear and quadratic terms. This value also represents the 1.0V level for the analog output.

Gas Decimal Point Maximum

Gas Decimal Point Maximum selects the number of digits to the right of the decimal point that are to be displayed. For example, if the expected readings are in the vicinity of 500 ppm, select whole numbers (zero digits). If the expected readings are in the 1 to 10 ppm range, select display readings to a tenth of a ppm (one digit). The following are suggested: select 2 places for values of 0 to 1, 1 place for values of 1 to 10, and 0 places for values >10. Remember that there is the option of changing units to ppb or percent levels.

Gas High Alarm Level

Gas High Alarm Level enables setting the high alarm level for the application. The last level configured is shown on the display. If this is the level for the present application, press **ENTER**. The display changes to the next parameter to be configured. Press **1** to change the level. The High Alarm Level Enter Display appears. Key in the desired level and press **ENTER**. If the entry is valid, the display responds "-ACCEPTED-" and then changes to the next parameter to be configured.

Gas Low Alarm Level

This parameter is similar to Gas High Alarm Level.

Gas STEL Alarm Level

This parameter is similar to Gas High Alarm Level.

Gas STEL Time Interval

The Gas STEL Time Interval is the interval for the STEL alarm for the application. The last interval configured is shown on the display. If this is the interval for the present application, press **ENTER**. The display changes to the next parameter to be configured. Press **1** to change the interval. The STEL Time Interval Selection Display appears. Select the interval for the application (Off, 5, 10, or 15 minutes). The display responds "-ACCEPTED-" and then changes to the next parameter to be configured.

Gas Molecular Weight

Gas Molecular Weight sets the molecular weight of the gas for the application. The last weight configured is shown on the display. If this is the weight for the present application, press **ENTER**. The display changes to the next parameter to be configured. Press **1** to change the weight. The Molecular Weight Enter Display appears. Key in the desired weight (000.0 to 999.9) and press **ENTER**. If the entry is valid, the display responds "-ACCEPTED-" and then changes to the next parameter to be configured. This value converts concentrations unit of measure to mg/m^3 .

Gas Liquid Density

Gas Liquid Density sets the density of the vapor for the application. The last density configured is shown on the display. If this is the density for the present application, press **ENTER**. The display changes to the next parameter to be configured. Press **1** to change the density. The Density Enter Display appears. Key in the desired density (0.00 to 9.99) and press **ENTER**. If the entry is valid, the display responds "-ACCEPTED-" and then changes to the next parameter to be configured. This value is for reference only, and is not used in any calculation.

Gas TWA Weighting

Gas TWA Weighting specifies the gas group TWA weighting of the gas for a multi-gas application. The last weight configured is shown on the display. If this is the weight of the present application, press **ENTER**. The display changes to the next parameter to be configured. Press **1** to change the weight. The TWA Weight Enter Display appears. Key in the desired weight (from 0 to 10000) and press **ENTER**. If the entry is valid, the display responds "-ACCEPTED-." If this is not the last gas in the application, the display returns to Gas Summary for the next gas. If this is the last gas in the application, the display changes to the next parameter to be configured, Wave Count.

The group TWA is calculated by dividing the instantaneous concentration for each gas by their respective GTWA weighting value, and then adding up all of the results. Time is factored into this value by logging the average concentration over the user-defined logging interval.

Wave Count

Wave Count sets the number of analytical wavelengths for the application. The last number configured is shown on the display. If this is the number for the present application, press **ENTER**. The display changes to the next parameter to be configured. Press **1** to change the number. The Wave Count Enter Display appears. Key in the desired number (1 to 10) and press **ENTER**. If the entry is valid, the display responds "-ACCEPTED-" and then changes to the Wavelength Summary.

Wavelength Summary

The Wavelength Summary reviews the wavelength position for each wave in the application. The display also indicates whether all humidity compensation parameters are zero or not (see Wavelength Summary Display, below). Move from one wave to the next with the arrow keys. To accept this data for each wave, press **ENTER**. When the last wave is reached, the display jumps to the Temperature Compensation Display. To change the data in the Wavelength Summary for a wave, press **1**. The Wavelength Position Display is presented.

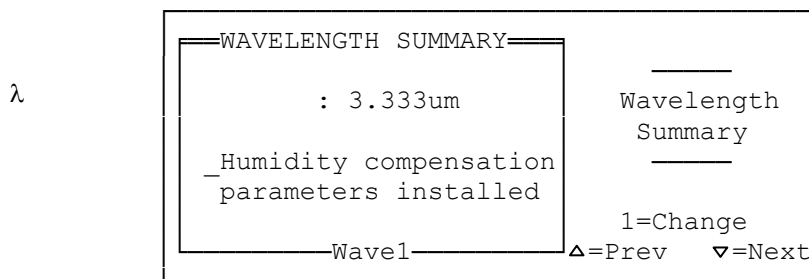

Wavelength Summary Display

Application Wavelength

Application Wavelength is the wavelength position defined for the installed application. This parameter enables the position to be changed.

Note: If this is a standard library application, the value cannot be changed.

The last wavelength position configured is shown on the display. If this is correct, press **ENTER**. The display changes to the next parameter to be configured. Press **1** to change the wavelength position. The Wavelength Position Enter Display appears. Key in the desired wavelength position (in μm) and press **ENTER**. If the entry is valid, the display responds "- ACCEPTED-" and then changes to the next parameter to be configured.

Correction for humidity may be necessary as water vapor is a strong absorber in the infrared, with frequently overlapping absorption bands of

Humidity to Absorbance Correction

Correction for humidity may be necessary as water vapor is a strong absorber in the infrared, with frequently overlapping absorption bands of many compounds of interest. The relationship between humidity level and absorption is often nonlinear. Humidity to Absorbance Correction specifies the coefficient for a P, Q, and R parameter, any of which may be assigned to Range 1, 2, or 3 for each wave for the application. The last wavelength absorbance for each range configured for a wave is shown on the display. To accept this data, press **ENTER**. When the last wave is reached, the display goes to the Temperature Compensation Display. To change absorbance values, press **1**. The Wavelength Range Select Display appears (see Wavelength Range Select Display, below)

=HUMIDITY ABSORB->H2O=		Select
: 12.345um		wave H2O range:
Range 1: -> 0.5000AU		1=Range 1
Range 2: -> 0.7500AU		2=Range 2
Range 3: ---		3=Range 3

Wavelength Range Select Display

Select the desired range (1, 2, or 3). The Parameter Select Display appears (see Parameter Select Display, below).

=HUMIDITY ABSORB->H2O=		Select
Range 1:4.8%		wave H2O parms:
Q= 0.000000E-00		1=Q
P=-7.890234E-01		2=P
R= 0.000000E+00		3=R
		4=Absorb range

Parameter Select Display

Select the desired parameter (P, Q, R, or Absorb range). The Parameter Enter Display appears. Key in the desired parameter coefficient (in the form 1.123456E-07) and press **ENTER**.

Note: Use the down arrow key for a minus sign.

If the entry is valid, the display indicates that the entry is **ACCEPTED** and then changes to the next parameter to be configured.

Water absorbance at the analytical wavelengths is a percentage of the absorbance at the water wavelengths. A general relationship for all analytical wavelengths is defined in Appendix D. The appropriate values are used for each analytical wavelength.

Note: This table only contains P term values because this is all that is required for humidity compensation.

Temperature Compensation

Temperature Compensation sets the temperature compensation off or on. The last compensation condition configured is shown on the display. If this is the compensation condition for the present application, press **ENTER**. The display changes to the next parameter to be configured. Press **1** to change the compensation condition. The Temperature Compensation Select Display appears (see Temperature Compensation Display, below). Select the condition for the application (Off or On). The display responds "-ACCEPTED-" and then changes to the next parameter to be configured.

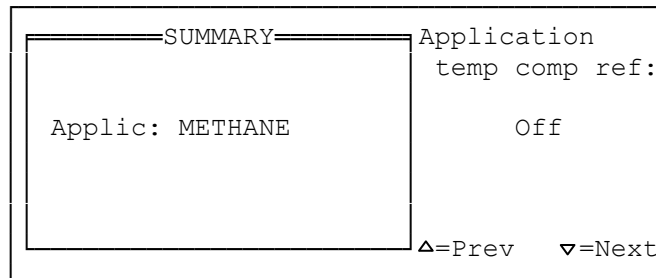

Temperature Compensation Display

Pressure Compensation

Pressure Compensation sets the pressure compensation off or on. The last compensation condition configured is shown on the display. If this is the compensation condition for the present application, press **ENTER**. The display changes to the next parameter to be configured. Press **1** to change the compensation condition. The Pressure Compensation Select Display appears (see Pressure Compensation Display, below). Select the condition for the application (Off or On). The display responds "-ACCEPTED-" and then changes to the Reference Compensation Summary.

Note: There is no pressure sensor in the instrument. If pressure compensation is enabled the user is prompted to enter the ambient pressure prior to running any application.

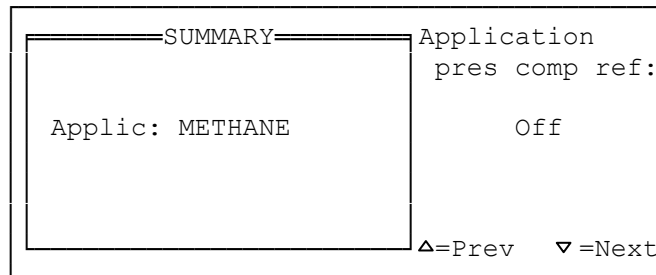

Pressure Compensation Display

Reference Compensation Summary

Since the SapphIRe analyzer is a single beam infrared spectrophotometer, any changes to the analyzer which may cause drift are associated as changes to the detector signal compared to the zero signal. As the analyzer warms up, changes to the electronics, the infrared filter, and the gas cell affect the data. To overcome these subtle changes, rezero the analyzer more often.

Another way to mitigate these effects and to increase the stability of the data is to employ reference compensation. Reference compensation repeatedly compares the detector signal at a non-absorbing wavelength to the signal at the analytical wavelength. The processor then compares these two signals to the associated signal during the zero cycle. The analytical wavelength signal is then adjusted, if necessary, to compensate for any shift.

Choosing the correct reference wavelength is very important. All the calibrations in the fixed library have a reference wavelength of 4.004 microns associated with the calibration. By enabling reference compensation, the analyzer uses 4.004 microns as the wavelength. This wavelength filter was chosen because there are virtually no gases that absorb at this wavelength. The problem with this wavelength is that it is not completely similar to other analytical wavelengths. However, using this reference wavelength provides suitable compensation for most applications. If this compensation is inadequate, it may be necessary to use a different reference wavelength. Ideally, the wavelength should be close to the analytical wavelength. For example, if ETO is measured at 11.6 microns, then a wavelength in the 10 to 12 micron range should be chosen. However, the wavelength that is chosen must be a non-absorbing wavelength for the primary gas and any interfering gases. Choosing a wavelength that is affected by another gas can cause significant errors in the displayed data if that gas is present. The goal is to factor out wavelength neutral changes due to the analyzer. If the signal for the reference wavelength is increased by a gas, the correction by the processor will most likely be overstated.

Before choosing a different wavelength, the parameters in the Fixed Library must be transferred to a User Library entry. This is the only way to edit any parameter in fixed library calibrations.

The Reference Compensation Summary allows reviewing the reference compensation data for the application (see Reference Compensation Summary Display, below). To accept this data, press **ENTER**. The display jumps to the Humidity Compensation Display. To change the data in the Reference Compensation Summary, press **1**. The Reference Compensation Mode Display is presented.

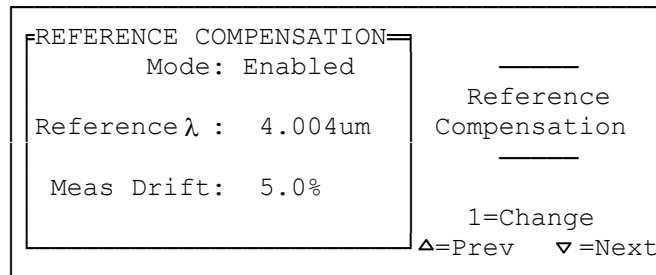

Reference Compensation Summary Display

Reference Compensation Mode

Reference Compensation Mode sets this mode as Off or Enable. The last mode condition configured is shown on the display. If this is the mode condition for the present application, press **ENTER**. The display changes to the next parameter to be configured. Press **1** to change the mode condition. The Mode Select Display appears. Select the condition for the application (Off or Enable). The display responds "-ACCEPTED-" and then changes to the next parameter to be configured.

Reference Wavelength

Reference Wavelength specifies the reference wavelength. The last reference wavelength configured is shown on the display. If this is the desired wavelength, press **ENTER**. The display changes to the next parameter to be configured. Press **1** to change the wavelength. The Wavelength Enter Display appears. Key in the desired wavelength (in μ m) and press **ENTER**. If the entry is valid, the display responds "-ACCEPTED-" and then changes to the next parameter to be configured.

Reference Measured Drift

Reference Measured Drift specifies the percent change of intensity at the reference wavelength between the zero and the measurement cycles prior to displaying a reference drift error. The last reference measured drift configured is shown on the display. If this is the correct allowed drift, press **ENTER**.

The display changes to the Humidity Compensation Summary. Press **1** to change the allowed drift. The Reference Measured Drift Enter Display appears. Key in the desired allowed drift (0.0 to 100.0) and press **ENTER**. If the entry is valid, the display responds "-ACCEPTED-" and then changes to the Humidity Compensation Summary.

To convert percent to an absorbance limit value, use the following formula:

$$\text{Absorbance Limit} = \log_{10} \left(\frac{100}{100 \pm \text{drift}} \right)$$

For example, if the drift value was set to 25 percent, a drift flag is generated if the absorbance at the reference wavelength is over 0.1245 AU or under -0.0969 AU.

Humidity Compensation Summary

The Humidity Compensation Summary allows reviewing the humidity compensation data for the application. To accept this data, press **ENTER**. The display jumps to the Pathlength Display. Press **1** to change the data in the Humidity Compensation Summary. The Humidity Compensation Mode Display is presented (see Humidity Compensation Summary Display, below).

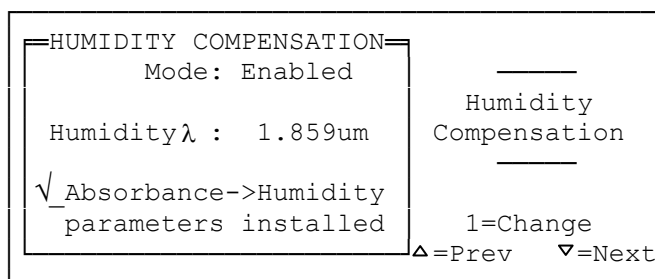

Humidity Compensation Summary Display

Humidity Compensation Mode

Humidity Compensation Mode sets this mode off or on. The last mode condition configured is shown on the display. If this is the mode condition for the present application, press **ENTER**. The display changes to the next parameter to be configured. Press **1** to change the mode condition. The Mode Select Display appears. Select the condition for the application (Off or On). The display responds "-ACCEPTED-" and then changes to the next parameter to be configured.

Humidity Wavelength

Humidity Wavelength enables specifies the humidity wavelength (usually the humidity filter wavelength of 1.859 μm). The last humidity wavelength configured is shown on the display. If this is the desired wavelength, press **ENTER**. The display changes to the next parameter. Press **1** to change the wavelength. The Wavelength Enter Display appears. Key in the desired wavelength (in μm) and press **ENTER**. If the entry is valid, the display responds "-ACCEPTED-" and changes to the next parameter to be configured.

Humidity Absorbance

Humidity Absorbance specifies the coefficient for a P, Q, and R parameter or the maximum absorbance value, any of which may be assigned to Range 1, 2, or 3 for the application. The last humidity absorbance value for each range configured is shown on the display. To accept this data, press **ENTER**. The display jumps to the Pathlength Display. To change the absorbance values, press **1**. The Humidity Range Select Display appears (see Humidity Range Select Display, below).

```
HUMIDITY ABSORB->H2O Select
λ : 1.859 um wave H2O range:
Range 1: to 4.8000AU 1=Range 1
Range 2: --- 2=Range 2
Range 3: --- 3=Range 3
```

Humidity Range Select Display

Select the desired range (1, 2, or 3). The Humidity Parameter Select Display appears (see Humidity Parameter Select Display, below).

```
HUMIDITY ABSORB->H2O Select
Range 1: to 4.8000AU wave H2O parms:
Q= 0.000000E+00 1=Q
P=-1.000000E+00 2=P
R= 0.000000E+00 3=R
4=Absorb range
```

Humidity Parameter Select Display

Select the desired parameter (P, Q, R, or Absorb Range). The Humidity Parameter Enter Display appears. Key in the desired parameter coefficient (in the form 1.123456E-07) and press **ENTER**.

Note: Use the down arrow key for a minus sign.

If the entry is valid, the display responds "-ACCEPTED-" and then changes to the Humidity Parameter Range Select Display. Another parameter can be selected, or press **ESC** to return to Humidity Range Select and **ESC** again to return to Humidity Absorbance. Pressing the down arrow key at this point, goes to the next parameter, Pathlength.

Normal practice is to set absorbance range 1 to 4.8000 AU, and to set its P value to 1.0. During analysis, this copies the absorbance data to the humidity data for later use.

Pathlength

Pathlength specifies a long or short pathlength. The last pathlength condition configured is shown on the display. If this is the pathlength condition for the present application, press **ENTER**. The display changes to the next parameter to be configured. Press **1** to change the pathlength condition. The Pathlength Select Display appears. Select the condition for the application (Long or Short). The display responds "-ACCEPTED-" and then changes to the next parameter to be configured.

Dwell Time

Dwell Time specifies the time analysis stays on a wavelength and averages measurement data. The last dwell time configured is shown on the display. If this is the desired dwell time, press **ENTER**. The display changes to the next parameter to be configured. Press **1** to change the dwell time. The Dwell Time Enter Display appears. Key in the desired dwell time (0 to 65535) and press **ENTER**. If the entry is valid, the display responds "-ACCEPTED-" and then changes to the next parameter to be configured. Typical dwell time is 275 (5 second analysis time). Consult a Thermo Fisher Scientific applications chemist for any dwell time change.

Purge % of Max

Purge % of Max specifies the percent of maximum sample cell purge to perform. For most gases, 60 seconds or 100% provides enough flushing of the gas cell to clear the previous sample. At a flow rate of approximately 14 liters/minute and a cell volume of approximately 2.2 liters, the SapphIRe analyzer has provided about six volumes of air. Typically, 5 volumes of air will purge the cell by 99%. Although certain gases can be flushed faster, setting percent of purge parameter to 100% is recommended.

The last percent of purge configured is shown on the display. If this is the desired percent of purge, press **ENTER**. The display changes to the next parameter to be configured. Press **1** to change the percent of purge. The Percent of Purge Enter Display appears. Key in the desired percent of purge (0 to 100) and press **ENTER**. If the entry is valid, the display responds "-ACCEPTED-" and then changes to the next parameter to be configured.

Batch Mode

Batch Mode enables or turns off this mode. The last mode condition configured is shown on the display. If this is the desired mode condition for the present application, press **ENTER**. The display changes to the next parameter to be configured. Press **1** to change the mode condition. The Mode Select Display appears. Select the condition for the application (Enabled or Off). The display responds "-ACCEPTED-" and then changes to the next parameter to be configured.

If Batch Mode is enabled, the analyzer performs a trap and purge routine. This turns the pump off during the measurement of all analytical wavelengths. This ensures the sample is measured at all analytical wavelengths, allowing for proper compensations if necessary. Once the analysis is completed, the pump is turned back on to draw in a new sample, and the process is repeated.

Batch Purge %

Batch Percent of Purge specifies the percent of maximum gas cell purge to perform during a batch sampling mode. As described in “Batch Sample”, above, Batch Percent of Purge can be changed when faster updates of the data are required. The batch cycle consists of three portions. In the first portion, batch purge, the pump draws in a new sample or batch of gas. This lasts 20 seconds if Batch Percent of Purge is set to 33%. In those 20 seconds about 4.5 liters (2 volumes) of gas are drawn into the cell. By entering 25%, this portion of the cycle lasts 15 seconds and draws about 3.5 liters (1.5 volumes) of gas.

The second portion of the cycle is the measurement of the gas at each of the wavelengths. To see the analyzer measuring the wavelengths, press the up arrow key to view the Intensity or Absorbance screen (if enabled). The third portion of the cycle is the display of the data.

By changing the Batch Percent of Purge to a lower value, reduce the cycle time. However, by doing this, each successive sample measurement shows a smaller step change since the gas cell is not being refreshed as quickly. In a static or constant concentration location, this may not be a problem.

In the Batch Percent of Purge parameter, the last batch percent of purge configured is shown on the display. If this is the desired percent of purge, press **ENTER**. The display changes to the next parameter to be configured. To change the batch percent of purge, press **1**. The Batch Percent of Purge Enter Display appears. Key in the desired percent of purge (0 to 100) and press **ENTER**. If the entry is valid, the display responds "-ACCEPTED-" and then changes to the next parameter to be configured.

Measurement Absorbance → Concentration

Measurement Absorbance → Concentration specifies the coefficient for a P, Q, and R parameter or the maximum absorbance value, any of which may be assigned to Range 1, 2, or 3 for the application. The last measurement Absorbance → Concentration value for each range configured is shown on the display. To accept this data, press **ENTER**. The display returns to the Primary Name Display (see above). Press **1** to change the absorbance values. The Meas Absorb → Conc Range Select Display appears (see Meas Absorb → Conc Range Display, below).

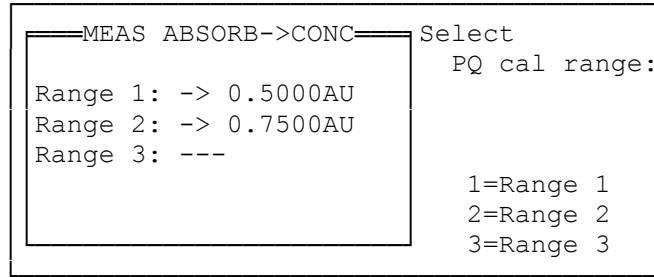

Meas Absorb → Conc Range Select Display

In the above example, the calibration range from 0 to 0.1700 AU has one set of calibration curve data (P,Q values) and the range from 0.1701 to 0.4000 AU has a second set of calibration values. The reason for more than one set of calibration values is that the first range may be relatively linear whereas the second range may be less linear. By creating two separate ranges, the accuracy is significantly enhanced.

Select the desired range (1, 2, or 3). The Meas Absorb->Conc Parameter Select Display appears (see. Meas Absorb → Conc Parameter Select Display, below).

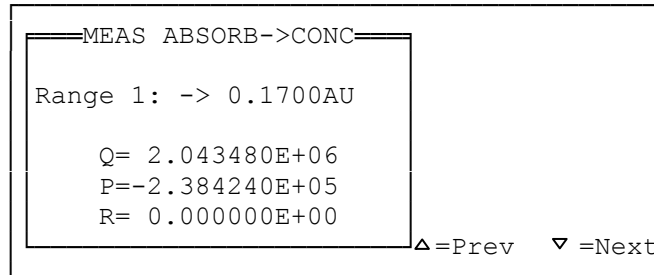

Meas Absorb → Conc Parameter Select Display

The analyzer functions by measuring absorbance of light at the detector. Once the absorbance is generated by the analyzer, it needs to be converted in concentration. To accomplish this, the absorbance value is fitted into the following formula:

$$C = QA^2 + PA + R$$

where:

- C = Concentration of the chemical
- Q = Quadratic parameter
- P = Linear Parameter
- R = Y-intercept (typically zero or very close to zero)
- A = Absorbance

If in this example, the analyzer generates an absorbance value or 1.00, the following concentration value is generated:

$$C = 2,043,480 (0.100)^2 + 239,424 ((0.1) + 0.00$$

$$C = 20,434.80 + 23,942.40 = 44,377.20 \text{ ppb}$$

Chapter 7 Configuration and Setup

The value is always expressed in ppb. The conversion results in a displayed value determined by the application. If the absorbance value generated by the analyzer had been greater than 0.1700, range 2 P, Q, and R values would be used.

Select the desired parameter (P, Q, R, or Absorb Range). The Meas Absorb->Conc Parameter Enter Display appears. Key in the desired parameter coefficient (in the form 1.123456E-07) and press **ENTER**.

Note: Use the down arrow key for a minus sign.

If the entry is valid, the display responds "-ACCEPTED-" and then changes to the Meas Absorb->Conc Parameter Range Select Display. Another parameter can be selected or press **ESC** to return to Meas Absorb → Conc Range Select and **ESC** again to return to Meas Absorb->Conc. Pressing the down arrow key at this point, returns to the Primary Name Display (see Primary Name Display, above).

Matrix Parameters

Matrix Parameters is used for multigas applications. It specifies the coefficient for a P and Q parameter for each part of the matrix. The last coefficients configured are shown on the display.

MATRIX PARAMETERS		
Gas	Wavelength	Matrix
3	2	absorb->concent
Q= 1.123456E-07		
P=-7.890234E+05		
		△=Prev ▽=Next

Matrix Parameters Display

To accept this data for the column and row indicated, press **ENTER**. The display for the next row in the matrix appears; or if the current matrix is in the last row, the display for the next column, first row appears; or if the current matrix is in the last column, last row, the display returns to the Primary Name Display (see Primary Name Display, above). To change the coefficients, press **1**. The Matrix Parameter Select Display appears. Select the desired parameter (P or Q). The Matrix Parameter Enter Display appears. Key in the desired parameter coefficient (in the form 1.123456E-07) and press **ENTER**.

Note: Use the down arrow key for a minus sign.

If the entry is valid, the display responds "-ACCEPTED-" and then returns to the Matrix Parameters Display. The next position in the matrix can then be configured. When done, press the **ESC** key. For more information on calibration parameters of multicomponent applications, see LAD 001-036.

Save Changes to Library

If the current application has been changed from the library, the display prompts "Application is changed!" and asks "Save changes to library?" Press **ENTER** to Save, **ESC** to not save.

<p>Note: For step-by-step calibration procedures see Appendix E, "Scan/Calibration Procedure."</p>

Chapter 8

SITE INFO

Sites and locations are storage locations for logged data within the SapphIRe memory. A site is the collection point for logged data - concentration, date, time, absorbance data, and possibly locations. A location is specific identity assigned to logged data.

Note: PCIP is a DOS program. If there is a communication problems in a Windows environment, it may be necessary to restart the computer in DOS mode. Contact the local MIS staff or Thermo Fisher Scientific if problems persist.

SITES

Before any data can be logged, a site must be created through the keypad of the SapphIRe (see steps that follow) and the logging parameters must be configured. This site holds all of the data that has been logged until a new site is created or the existing is site is erased. When a new site is created, the current site (and logged data) is not lost, only closed. The analyzer warns of this when a new site is created. The data may be still be accessed by downloading to the computer through ThermoConnect, or printed through the printer port.

Creating a New Site

1. From the main menu, select #3, Site Info, to access the Site Menu Display, shown below.

—STATUS—	SITE MENU
Site: <all>	1=New site
Locations: ---	2=Enter site information
Memory: 94% free	3=Erase site

Site Menu Display

2. From the site menu - select # 1 (new site)
3. The warning "Starting a site closes the old site data" may appear. Press **ENTER**.
4. Enter the name of the site through the keypad. The site name may be up to twelve characters long. Press **ENTER**.
5. The new site name is displayed on the left and the site menu is returned. Press **ESC** to return to the main menu.

General Comments

1. There may have up to 50 sites in the analyzer memory at one time.
2. When downloading or printing site data, select either a single site, all sites, or current site.
3. Selection # 2 (enter site information) under the site menu allows the entering of notes about the data to be logged. For example, notes could indicate the conditions at the time of monitoring ("cloudy"), or who requested that the monitoring be done ("I.H. survey"). This information will appear at the end of the standard logging report. The default setup provides 20 note locations, each of which may be up to 12 characters long.
4. To clear all sites and logged data, select # 5 (Report/Data) from the main menu, then select # 4 (Memory Clear). Select # 1 from the memory menu to clear the sites and logged data (see Memory Clear Display, below). See "Locations" for clearing all locations.

```
-----SUMMARY-----
      Site: <all>
Locations: ---
Memory: 94% free

MEMORY MENU
1=Clear logged
  sites & data
2=Clear all:
  -logged data
  -locations
  -report defin
```

Memory Menu Display

LOCATIONS

Locations are reusable identifiers that may be used to identify data within a site. For example, if monitoring homes, the locations "kitchen", "hall", "bedroom", "living" and "dining" can be established. When entering the first home, an appropriate site name (i.e., "123 Main St") and the logging parameters can be established. Then scroll through the five locations and log the data for the appropriate room(s). When moving to the next home, a new site ("987 Oak Lane") would be established, and the process would be repeated. There are three types of locations:

1. **Standard Locations** - These are "permanent" locations that are entered into the analyzer's memory and may be used in all sites. The locations in this list become the active location list when the location feature is activated and a new site is created. The location list is created on a PC and sent to the analyzer. To create a location file, download the blank location list from the analyzer to be used as a template. The spacing in the file is critical; if improperly formatted, an error message will appear during the data transfer to the analyzer. To ensure correct spacing, position the cursor after the placeholder "<none>", backspace to the "=" sign, and enter the desired location (up to 12 characters long). To enter a second location, copy the current line and paste it to a new line. Modify this new line as

noted above. Repeat this process for as many locations as needed. There should be one blank line after the version line and another blank line prior to the end line. These locations will be available in all sites, and will reside even after the memory is cleared of sites and logged data. Examples of standard locations are shown below:

```
STANDARD LOCATIONS  
VERSION=1
```

```
LOCATION=DINING ROOM  
LOCATION=CLOSET-KIT  
LOCATION=CABINETS
```

```
END
```

2. **Supplemental Locations** - This is a secondary list of "permanent" locations that may be loaded into the SapphIRe in the same manner as the standard locations (in the setup file under the heading "supplemental locations") - see above for the process. The supplemental location could be used if an infrequent location exists (i.e., garage) that is not used every monitoring session, but may be needed on occasion. To use these supplemental locations, add them to the active location list. These supplemental locations are available only in the site currently open. Once the site is closed, add these locations once again in the newly created site (however, the data logged to the supplement locations in the closed site will be visible when the data is downloaded or printed). Examples of supplemental locations are shown below:

```
SUPPLEMENTAL LOCATIONS  
VERSION=1
```

```
LOCATION=BOILER RM  
LOCATION=COOLER  
LOCATION=COUNTER
```

```
END
```

3. **Added Locations** - Add "temporary" locations to the current location list as needed at any time. These locations are entered through the keypad, exist only for the open site, can be logged but can not be saved. Typical uses of this type of location are if an unusual tag is needed (i.e., doghouse) that would be of very little use in the future. These locations could be used if a unique identifier is needed for a specific data point. Once the site is closed, these locations need to be added once again in the newly created site (however, the data logged to the supplement locations in the closed site will be visible when the data is downloaded or printed).

How to Use Locations

1. Create standard (and supplemental if desired) locations by downloading the location template from the analyzer to a PC.
2. Modify the location list and load into the analyzer.
3. Scroll to next page by pressing ↓. Activate selection # 2 (location) on the analysis setup preference menu.
4. Activate selection # 3 (location list) on the analysis setup menu #3. Change the order of the location and establish how locations are inserted into the list in this menu.
5. When in the analysis mode, the first location in the active location list will appear in the bottom solid bar on the left of the display. Scroll through the current locations by pressing the “6” and “9” buttons or, if configured, the up and down arrows.
6. Selection # 3 (location menu) provides access to the current list menu. This provides the following options:
 - Selection # 1(Browse) allows scrolling through the current locations. Selecting one of the listed locations makes that location active.
 - Selection # 2 (Add or search) allows searching for a specific current location or to add a temporary location to the active location list. Pressing enter makes that location active.
 - Selection # 3 allows scrolling through the supplemental location list. It performs the same functions as selection # 1 (above), except it makes that supplemental location active and loads the supplemental location to the active location list **as long as that site is open.**
 - Selection # 4 allows searching for a specific supplemental location. Pressing enter make that makes that supplemental location active and loads the supplemental location to the active location list **as long as that site is open.**

General Comments

1. There may be up to 200 total locations (standard, supplemental, and added) loaded per site.
2. Locations are a valuable tool if the same area is continually monitored. For many applications a descriptive site name (and perhaps a note) may suffice.
3. If a single sample as the log mode is selected, the left hand side of the main menu will display the number of locations that are logged and the total number of active locations. When in the analysis mode, this allows logging a single location and then prompts to save or repeat the log. If the log is saved, it steps to the next location and the process is repeated. If the analysis is stopped prior to logging all locations and restart the analysis, the locations list begins at the start of the list, but a check mark is placed next to those locations that were already logged.

4. Since standard locations and supplemental locations are loaded from a PC and are "permanent", the only way to remove these is to clear the entire memory. To clear all memory, press **5** (Report / Data), then select **4** (memory clear) from the Report/Data menu. At the Memory Menu, press **2** (clear all: -logged data, -locations, -report defin). Please note that performing this function does not remove the report format from the analyzer, it loads the default report format from flash memory. If a custom report format was used, it must be reloaded.
5. It is possible to create several location files and send them into the analyzer as needed (the one being sent into memory overwrites the exiting one). This may be helpful if the monitor patterns include homes (examples provided earlier), hospitals (locations may be OR1, OR2, Recovery1, Sterilizer1) or painting operations (spray booth1, vent hood1, drying area, storage room).

SITES and LOCATIONS SUMMARY

A site is a memory location that holds logged data and has a limited life. It must be created to log data and take a few seconds to establish. Locations come in various types, and may be either permanent or temporary. It takes a more substantial effort to develop them, but the standard and supplemental locations are reusable. Below is a block diagram that represents how they interact.

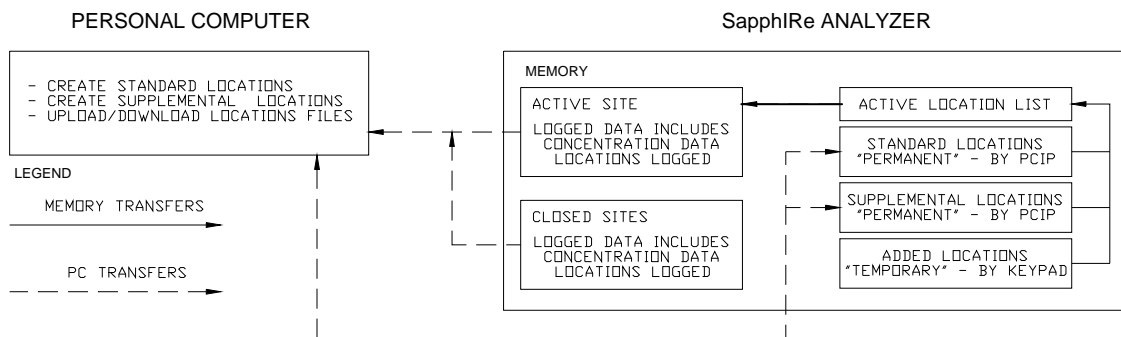

Figure 8-1. Sites and Locations Block Diagram

Chapter 9

Report/Data Transfer

Warning: Intrinsically safe models require special actions with respect to the following section. Refer to Appendix C for descriptions of these actions.

From the Main Menu, press **5** (Report/Data) to access the Report/Data Menu (see Report/Data Menu, below). The current status is shown on the left and the menu of selections on the right.

STATUS	REPORT/DATA
Site: 1234 MY ST	1=Select site
Locations: 30 of 35 logged	2=Print
Memory: 85% free	3=Data transfer
	4=Memory clear

Report/Data Menu

SELECT SITE

To select a site, press **1** (Select site) from the Report/Data Menu. If no sites are available, the display reads "No sites are logged." If sites are available, the Site List Menu is displayed (see Site List Menu, below). The current status continues to be shown on the left and the menu of selections on the right. Select the site by its number. The display responds "-ACCEPTED-."

STATUS	SITE LIST
Site: 1234 MY ST	0=All sites
Locations: 30 of 35 logged	.=Current Site
Memory: 85% free	2=24 OAK ST
	2=24 OAK ST
	3=678 MAPLE ST
	4=9 MAPLE ST

Site List Menu

PRINT MENU

Warning: Intrinsically safe models require special actions with respect to the following section. Refer to Appendix B for descriptions of these actions.

To print a report, connect the analyzer to any printer that can accept ASCII text format by connecting the printer cable (see Figure 3-1) to the analyzer parallel port (see Figure 3-8).

Then, press **2** (Print) from the Report/Data Menu. The Print Menu is displayed (see Print Menu, below). The current status continues to be shown on the left and the menu of selections on the right.

<p>-----STATUS----- Site: <all> Locations: --- Memory: 94% free</p>	<p>PRINT MENU 1=Site ----- 2=Full setup 3=Partial setup ----- 4=Library names</p>
---	---

Print Menu

Press **1** (Site) from the Print Menu, to send data on the site selected in Setup mode to the printer. If no site was selected, the display reads "No site is selected."

Press **2** (Full setup), to send all data as specified in the Setup mode to the printer.

Press **3** (Partial setup), to access the Partial Setup Menu (see Partial Setup Menu, below).

From this secondary menu, the information can be printed only for the parameter specified (general setup, single gas user library, report format definition, location list, or supplemental location list). The current status continues to be shown on the left and the menu of selections on the right. Select the report by its number. Press **4** (Library names), to send the primary and secondary names of all applications to the printer.

<p>-----STATUS----- Site: <all> Locations: --- Memory: 94% free</p>	<p>PARTIAL SETUP 1=General setup 2=User library 3=Report format 4=Location list 5=Supplemental locations</p>
---	--

Partial Setup Menu

While printing, an indicator shows the percentage complete. When complete, the message "Print Transfer Okay" is displayed. If unable to print the report, the analyzer displays the message "Printing Failed."

DATA TRANSFER

To transfer data, connect the analyzer to a computer with an RS-232 cable and press **3** (Data transfer) from the Report/Data Menu. One of two Data Transfer Menus (one for auto data transfer mode and one for manual data transfer mode) is displayed (see Data Transfer Menus, below). The current status is shown on the left. The current mode and baud rate is shown on the right as well as the opportunity to change the mode or baud rate and to send or receive data.

<p>STATUS</p> <p>Site: <all></p> <p>Locations: ---</p> <p>Memory: 94% free</p>	<p>DATA TRANSFER</p> <p>Mode=Auto</p> <p>Baud=9600</p> <p>1=Change mode</p> <p>2=Change baud</p> <p>3=Send/receive</p>
--	--

<p>STATUS</p> <p>Site: <all></p> <p>Locations: ---</p> <p>Memory: 94% free</p>	<p>DATA TRANSFER</p> <p>Mode=Manual</p> <p>Baud=38400</p> <p>1=Change mode</p> <p>2=Change baud</p> <p>3=Send</p> <p>4=Receive</p>
--	--

Data Transfer Menus

Change Mode

To change mode, press **1** (Change mode) from the Data Transfer Menu. Select 1 = Auto or 2 = Manual.

Change Baud Rate

To change baud rate, press **2** (Change baud) from the Data Transfer Menu. Select 1 = 19200, 2 = 9600, 3 = 4800, 4 = 2400, or 5 = 1200.

Send Data

To send data, press **3** (Send) from the Data Transfer Menu. If mode is Auto, the display shows the percent transfer complete as the data is sent. If mode is Manual, the Send Menu is displayed (see Send Menu, below). The current status continues to be shown on the left and the menu of selections on the right.

STATUS	SEND MENU
Site: <all>	1=Site
Locations: ---	2=Full setup
Memory: 94% free	3=Partial setup
	4=Library names

Send Menu

Press **1** (Site) from the Send Menu, to send data on the site selected in Setup mode to the printer. If no site was selected, the display reads "No site is selected."

Press **2** (Full setup), to send all data as specified in the Setup mode.

Press **3** (Partial setup), to access the Partial Setup Menu (see Partial Setup Menu, above).

From this secondary menu information can be sent only on the parameter specified (general setup, single gas user library, multi-gas user library, report format definition, location list, or supplemental location list). The current status continues to be shown on the left and the menu of selections on the right. Select the information by its number.

Press **4** (Library names), to send the primary and secondary names of all applications.

Receive Data

To receive data, press **3** (Send/receive) from the Data Transfer Menu if in Auto mode or **4** (Receive) if in Manual mode.

While sending or receiving, an indicator shows the percentage complete. When complete, the message "Transfer Complete" is displayed. If unable to transfer the information, the analyzer displays the message "Transfer Failed."

MEMORY CLEAR

To clear memory, press **4** (Memory clear) from the Report/Data Menu. The Memory Menu is displayed (see Memory Menu, below). The current status continues to be shown on the left and the menu of selections on the right. Press **1** to clear logged data and sites. Press **2** to clear all data. This also removes all locations and replaces the report format with the default report format. The warning message "Clearing will erase stored data" is displayed. Press **ESC** to cancel request or **ENTER** to continue. The instrument responds: "Please wait while clearing memory." When finished, the display responds "CLEARED."

<p>SUMMARY</p> <p>Site: <all></p> <p>Locations: ---</p> <p>Memory: 94% free</p>	<p>MEMORY MENU</p> <p>1=Clear logged sites & data</p> <p>2=Clear all: -logged data -locations -report defin</p>
---	---

Memory Menu

Caution: Press **2** only if the report definition or location list are being changed.

HYPERTERMINAL

To transfer data between the analyzer and a PC, the MIRAN SapphIRe is shipped with the ThermoConnect program. Although any terminal program that works under the PC's operating system may be used to communicate with the analyzer, Hyperterminal is a widely available program that ships with Windows 95/98/ME, and Windows NT/2000. Appendix E describes the use of this program.

Chapter 10

Maintenance and Service

The SapphIRe analyzer has no user-serviceable parts and requires no lubrication or routine cleaning. With the exception of the battery pack, all parts have an infinite storage life.

Warning: Intrinsically safe models require special actions with respect to the following section. Refer to Appendix C for descriptions of these actions.

ZERO GAS FILTER

The zero gas filter contains activated charcoal and should be stored in a sealed plastic bag when not in use. Saturation of the filter depends on the nature and concentration of contaminants. If a new cartridge produces an appreciably lower analyzer reading, the old cartridge should be discarded. Replace the cartridge after no more than 30 zero cycles and at least once a year. It is important to realize that this replacement frequency may be inadequate for some gases.

PARTICULATE FILTER

The useful life of the particulate filter depends upon the amount of particulate matter at the sampling point. If the filter becomes clogged, the sampling flow rate decreases resulting in a slow response. The particulate filter can also become contaminated with background gases, leading to faulty results. Replace the filter when the response time has increased noticeably, if the filter is suspect, or after 400 operating hours.

BATTERY PACK

Warning: Intrinsically safe models require special actions with respect to the following section. Refer to Appendix C for descriptions of these actions.

The battery pack supplied with the analyzer consists of six NiCd cells and requires no maintenance other than recharging. The battery pack can be operated and charged in any position. Both the Model 5025A and 5100A Charger/Power Supplies are designed to provide safe levels of charging current under all conditions without adversely affecting cell life. A fully discharged battery pack can be recharged in approximately four hours.

Note: Intrinsically safe models use a different battery pack from earlier models. The older battery packs cannot power the intrinsically safe model.

Long Term Storage

NiCd batteries discharge at the rate of 30% per month at room temperature. Be sure to fully charge any battery pack retrieved from storage prior to using it in the analyzer.

Recharging

For a complete description of battery pack operations with either the Model 5025A or Model 5100A Charger/Power Supply (see Chapter 3, “Charger/Power Supply”).

CARE OF OPTICS

High concentrations of some compounds, examples of which are listed in Table 10-1, may cause incorrect readings or degrade the analyzer's cell windows. This could lead to an error message and require replacement of the windows. The problem may be minimized by:

- Avoiding repeated exposure to such concentrations.
- Purging the analyzer thoroughly with clean dry air after exposure to such concentrations.

Table 10-1. Compounds That May Degrade Cell Windows

Compound	Concentration
Ammonia	250 ppm
Diethylamine	100 ppm
Dimethylamine	100 ppm
Ethanolamine	100 ppm
Hydrogen Cyanide	100 ppm
Hydrogen Fluoride	100ppm
Methylamine	100 ppm

SERVICE LOCATIONS

For additional assistance, service is available from exclusive distributors worldwide. Contact one of the phone numbers below for product support and technical information or visit us on the web at thermo.com/aqi.

1-866-282-0430 Toll Free
1-508-520-0430 International

Chapter 11

Firmware Update

INTRODUCTION

Warning: Intrinsically safe models require special actions with respect to the following section. Refer to Appendix C for descriptions of these actions.

Thermo Fisher Scientific updates the SapphIRE software, and periodically provides firmware feature enhancements/modifications to the analyzer. These enhancements can be upload to the analyzer via a personal computer and the serial port on the analyzer.

A communication link between the PC and the SapphIRE analyzer is required to install the updates. This link is provided by the Personal Computer Interface Program (PCIP) software. This program is contained on a 3-1/2-inch diskette that is supplied with each instrument. To use the program, create a subdirectory called PCIP205 on the PC and copy the files from the diskette into this new subdirectory. To execute the program, access this directory and run the file ThermoConnect.

The enhanced firmware is provided as self-extracting zipped files on diskette at the time of the firmware release. It may also be obtained by accessing the Thermo Fisher Scientific web site (<http://www.thermo.com/ih>), and selecting the software button.

Create a new subdirectory and save the download into this new directory (typically this file is named "SvVVVVV.exe", where the "S" denotes Sapphire and the v's denote the version release number).

Note: Thermo Fisher Scientific suggests that the new directory be created under the PCIP directory.

This file provides the four files necessary to upgrade the firmware. To execute, run the file and the four new files ("readme.txt", "changes.txt", "report.txt", and "M205.prm") will be extracted and reside in the same directory as the original file. Print the readme.txt file and follow the steps exactly as printed. The entire process, including reloading the full set-up should take approximately 35 minutes.

Caution: Remember to backup the full set-up file prior to uploading the new operating firmware.

Notes:

1. Thermo Fisher Scientific supplies two disks with each SapphIRE. One contains the ThermoConnect software and should be loaded as indicated above. The second contains instrument specific application files ("applic.txt"), a generic read me file ("readme.txt"), and a setup file ("setup.txt"). Thermo Fisher Scientific recommends copying these files to the same directory as the ThermoConnect files. Thermo Fisher Scientific also suggests copying the full setup from the analyzer to the PC prior to the first use (see the following procedure). This provides a backup of the general setup, application file, report format, locations and supplemental locations in one file in case the data needs to be restored at a later time.
2. Specific software version related files are included with each software release. Read the "readme.txt" and "changes.txt" files prior to proceeding.

PROCEDURE

Downloading Setup Information

When the new firmware is loaded to the SapphIRE analyzer, all setup and application information will be erased. This information can be manually re-entered. However, this process can be time consuming, especially if there are lengthy location lists stored. Therefore, prior to uploading the new firmware, download the present setup configuration for later uploading. To download this data:

From the analyzer's Main Menu, press **5** to access the Report/Data Menu, shown below.

STATUS	REPORT/DATA
Site:<all>	1=Select site
Locations: ---	2=Print
Memory: 94% free	3=Data transfer
	4=Memory clear

Report/Data Menu

From the Report/Data Menu, press **3** to access the Data Transfer Menu. There are two different Data Transfer Menus, depending on whether the mode is automatic for use with ThermoConnect, or manual for use with a third-party communication software.

```

-----STATUS-----
      Site: <all>
Locations: ---
Memory: 94% free

DATA TRANSFER
Mode=Auto
Baud=9600
1=Change mode
2=Change baud
3=Send/receive
    
```

```

-----STATUS-----
      Site: <all>
Locations: ---
Memory: 94% free

DATA TRANSFER
Mode=Manual
Baud=38400
1=Change mode
2=Change baud
3=Send
4=Receive
    
```

Automatic and Manual Data Transfer Menus

Connect the analyzer to the computer with a serial communication cable. Verify that the baud rate on the analyzer and that on the computer match. A baud rate of 19200 is considered standard. In PCIP, press **F2** for file, and select the directory to store the file. Type a file name (for example, "MYSETUP.TXT"). As it is being typed, the file name appears at the bottom of the screen. Press **ENTER** to end the file name. If ThermoConnect is being used, press **F5=Receive**, and then **F6=Full Setup**.

Uploading New Firmware

With the analyzer running, press the Firmware Update Switch on the analyzer with a thin rod such as a paper clip (see Figure 3-8 for location). The Firmware Update menu is displayed. Press the applicable number to select a language.

```

-----FIRMWARE UPDATE-----
                                     1.00
Select language: 1=English 2=Francais
                 3=Espanol 4=Deutsche

Enter=Continue
    
```

Firmware Update Menu

Press **ENTER** to continue to the Firmware Main Menu.

```
-----MAIN MENU-----  
Firmware version: 205 050000P  
Firmware validity: Valid  
  
1=Update firmware  
2=Validate firmware 3=Serial setup  
4=Details          5=Exit update mode
```

Firmware Main Menu

In the Firmware Main Menu, press **3** to display the Serial Menu.

In the Serial Menu, press **1** to select 19200 baud. The display briefly read “19200 ACCEPTED” and returns to the Serial Menu. Press **ESC** to return to the Firmware Main Menu. Then press **ENTER** or **1** to erase the present firmware. The display warns that the firmware is about to be erase. Press **ENTER** to continue.

```
-----SERIAL MENU-----  
  
Baud Rate  
19200  
  
1=Verify serial link 2=Baud rate
```

Serial Menu

The Loading Firmware screen is displayed. In ThermoConnect, highlight the M205.prm file and press **F6** to send the new software to the analyzer. This process takes about 25 minutes.

```
-----LOADING FIRMWARE-----  
Loading firmware using serial port...  
Waiting...  
  
Esc=Cancel
```

Loading Firmware Screen

When complete, the Firmware Main Menu is displayed (see Firmware Main Menu, above). Verify that firmware revision is correct and validity states are valid. Press **5** to exit. The analyzer restarts at this point and error messages related to the application are displayed. Proceed to the next section to reload the specific application.

Uploading Setup Information

Next, reload the file saved earlier into back to the computer. To do this, press **5** from the Analyzer Main Menu (see below). Then Press **3** from the Report/Data Menu to select Data Transfer (see Data Transfer Menus, above). The display indicates that it is waiting for a request. From the computer, highlight MYSETUP.TXT, and press **F6**. After the transfer is complete, select an application (or single gas) and begin analysis.

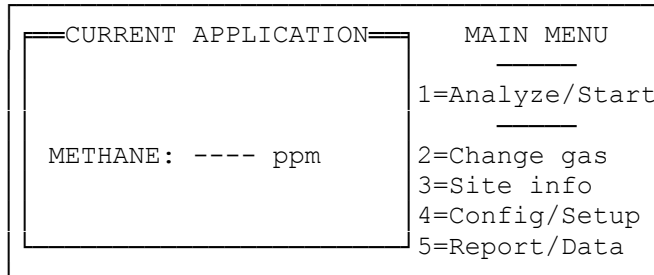

Analyzer Main Menu

Chapter 12

USER PERFORMANCE VERIFICATION

INTRODUCTION

Performance verification can be done by introducing a pure sample of the compound through a septum into a closed loop circulating pump which is connected to the analyzer. The closed loop calibration system, consisting of the septum, pump, and tubing is available from Thermo Fisher Scientific.

PROCEDURE

Warning: Intrinsically safe models require special actions with respect to the following section. Refer to Appendix C for descriptions of these actions.

1. Before connecting the closed loop calibration system to the analyzer, it must be free of all contaminants. Therefore, zero the analyzer (see Chapter 5, “To Zero the Analyzer”). When display says to install the particulate filter, go to next step of this procedure instead.
2. Connect tubing from the OUT connector of the closed loop pump to the IN port on the analyzer. Also connect tubing from the IN connector of the closed loop pump to the OUT port of the analyzer (see Figure 12-1).

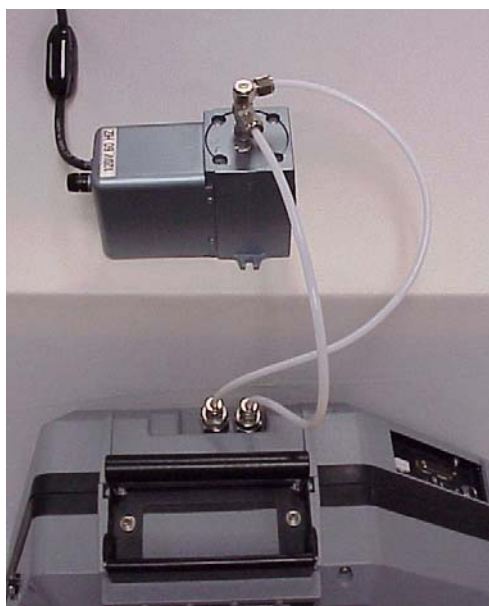

Figure 12-1. Closed Loop Calibration Setup

Chapter 12 User Performance Verification

- Determine the required injection volume for the calibration.

For Liquids:

$$VI = C \times \frac{V_T}{10^3} \times \frac{P}{R} \times \frac{M}{d}$$

For Gases:

$$VI = C \times V_T$$

Where:

VI = Injection volume in microliters (μL)

C = Concentration in parts per million (ppm)

V_T = Total volume of cell and calibration system in liters (2.24 L)

d = Liquid density (g/cm^3)

M = Molecular weight of sample

$$\frac{P}{R} = \text{Molar volume of gas} \left(\frac{1}{24.5} \text{ at } 25^\circ\text{C} \right)$$

- Press **ENTER** on the analyzer to continue. After a few seconds press **ENTE-R** again to skip purge. The current concentration (of approximately 0) is displayed.
- Make the injection of sample into the septum.
- The analyzer should read the concentration expected from the injection.

Note: Thermo Fisher Scientific offers a calibration kit (see Appendix E) that provides an alternative method of verification. Contact Thermo Fisher Scientific for more details.

Chapter 13

Infrared Spectroscopy Tutorial

OVERVIEW

The MIRAN SapphIRe Infrared Analyzer quickly measures concentrations of a wide range of chemical substances present in the air. In identifying and measuring various gases in the air, it uses fundamental principles of how molecules composing these substances absorb infrared energy.

Infrared energy is but one type of energy composing the electromagnetic spectrum. Other familiar types of electromagnetic energy are radio frequencies, microwaves, and visible light.

ELECTROMAGNETIC ENERGY

Figure 13-1 is a chart of the entire electromagnetic spectrum from electric power radiation to x-rays.

Electromagnetic waves can exist at virtually any frequency. Electromagnetic energy at the top of the spectrum (television and radio waves) have much longer wavelengths and correspondingly lower frequencies and energy than wavelengths towards the top of the chart (x-rays, gamma rays, and cosmic rays). The wavelengths of radio can be measured in dozens of feet whereas the wavelengths of x-rays can be measured in billionths of an inch.

Infrared energy is located toward the middle of the electromagnetic spectrum. It is in the same area as the only visible portion of the spectrum - light. The visible portion of the spectrum includes wavelengths from 0.4 to 0.7 μm (microns) or a slightly broader region under appropriate conditions. Thus the naked eye can only perceive a very small part of the electromagnetic spectrum.

At either end of the visible spectrum are invisible wavelengths. At longer wavelengths, just beyond the red end of the visible spectrum, is the infrared region (infra meaning frequencies below those of red light). Radiation in this region was demonstrated in 1800 by William Herschel, the English astronomer (Figure 13-2). Herschel placed a blackened thermometer just outside the red end of the spectrum of sunlight formed by a prism. He found that the temperature rose even though no visible light was hitting the thermometer. As this suggests, infrared radiation, like light, is a portion of the electromagnetic spectrum. But just as the pitch of sound can get too high or too low to hear, the wavelengths of light can get too long or too short to see. Although people cannot see infrared energy, they can feel it as heat. Radiated heat is infrared energy.

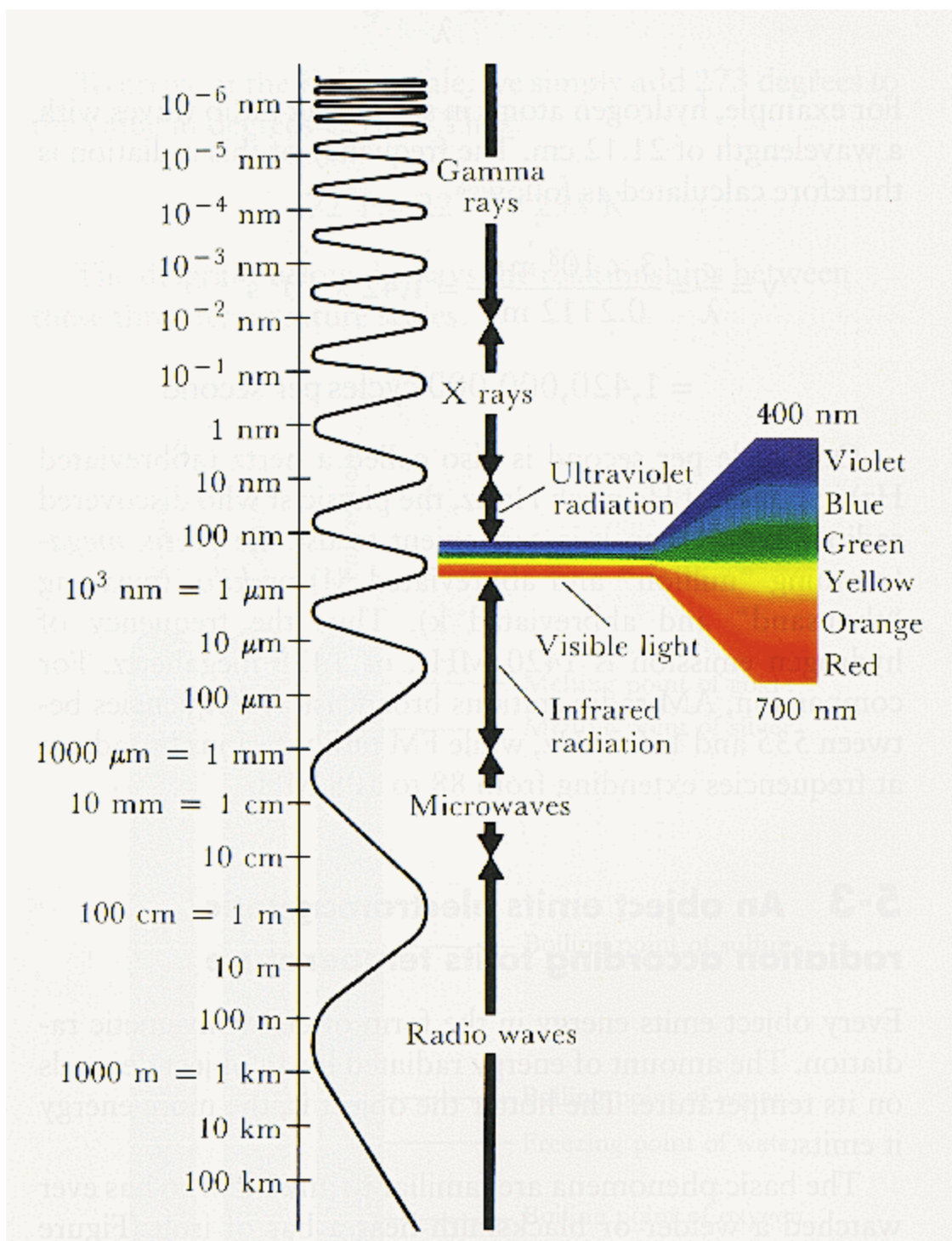

Figure 13-1. Electromagnetic Spectrum

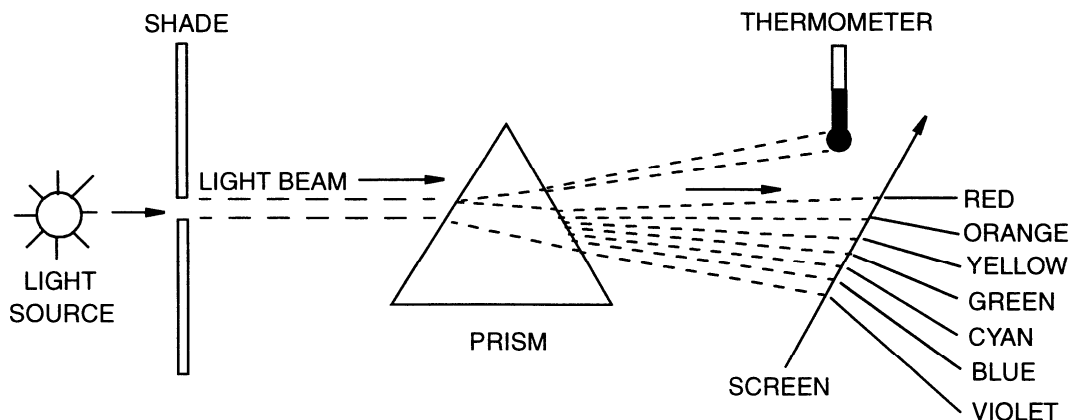

Figure 13-2. Herschel Experiment

People can see visible wavelengths as light and color but usually cannot feel them, whereas people can feel infrared wavelengths, but cannot see them.

Certain analytical instruments, however, such as the SapphIRe Analyzer, use infrared wavelengths from about 1.8 to 14.1 μm . This range was chosen because most chemical compounds show strong absorption of infrared energy in this region.

BASIC PROPERTIES OF WAVES

Wavelength

Figure 13-3 shows a cross-section of a typical wave, showing that the wave crests are evenly spaced. The distance from a point on one crest to the equivalent point on the next is called the wavelength, and is represented by the Greek letter lambda (λ). Infrared wavelengths are usually measured in micrometers (μm).

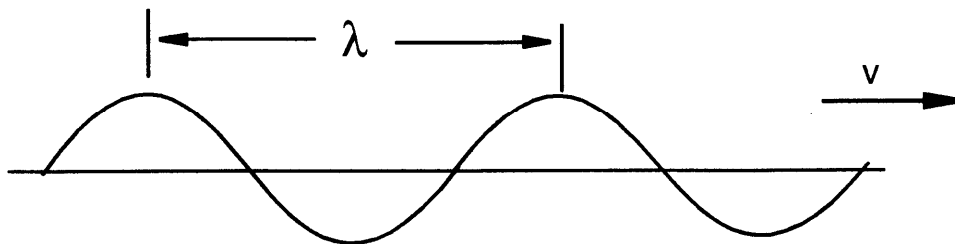

Figure 13-3. Explanation of a Wavelength

Speed and Frequency of the Wave

Velocity, V , of infrared waves in air is approximately the speed of light in a vacuum (c or 3×10^8 m/s). Whereas the velocity is expressed in distance travelled per unit of time, frequency measures how many waves pass a given point in a period of time. It is represented by the Greek letter Nu (ν) and expressed in cycles per second or Hertz (Hz). Thus the frequency equals the velocity divided by the wavelength or $\nu = c/\lambda$.

Wavenumber

A second unit of frequency used particularly in the optical regions of the spectrum (ultraviolet, visible, infrared) is the wavenumber in cm^{-1} , or cycles per centimeter. Wavenumber is represented by the barred Greek letter Sigma (σ). This unit is the reciprocal of wavelength, but unlike wavelength, it has the advantage of being linear with values measuring the energy of waves.

The following relationship simplifies conversions: $\sigma (\text{cm}^{-1}) = 10^4 / \lambda (\mu\text{m})$. That is, divide the wavelength (μm) into 10,000 to get the corresponding wave number or divide the wavenumber into 10,000 to get the wavelength.

ATOMS AND MOLECULES IN MOTION

The analysis of chemical compounds involves identifying both the type of molecules that comprise these substances (qualitative analysis) and the quantity of molecules present in a given sample (quantitative analysis). The SapphIRe Analyzer does both. It identifies quantities of known gases in the atmosphere and determines how much of those substances (their concentration) is in the sample. It does this by sending a beam of infrared energy at a selected wavelength through a sample of the substance and by measuring how much infrared energy gets through the sample. This section explains why this technique works by examining how atoms move and absorb energy.

Molecular Vibration

All substances are made up of atoms and molecules. Molecules are made up of two or more atoms held together by electrical forces to form chemical bonds. All molecules are dynamic, which means they are always in motion. One type of molecular motion is caused by the vibration of the atoms where they are bonded. These bonds can stretch or wag back and forth. The degree of molecular vibration or movement depends on the atoms, their bonds, and the amount of energy available. This motion is natural and occurs all the time. When a group of molecular atoms stretches or wags back and forth, it does so at a particular frequency.

Vibrational Bending and Stretching

Vibrations can involve either a change of bond length, stretching, or bond angle, bending (Figure 13-4).

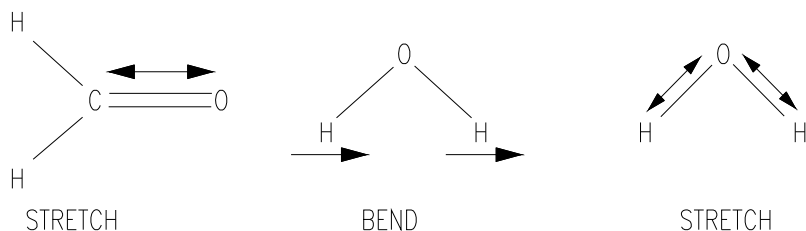

Figure 13-4. Molecular Bending and Stretching

Stretching can be either asymmetrical or symmetrical (Figure 13-5).

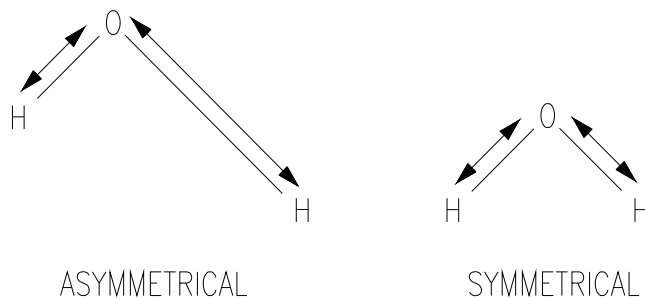

Figure 13-5. Asymmetrical vs Symmetrical Stretching

Bending can be described in four separate modes (Figure 13-6).

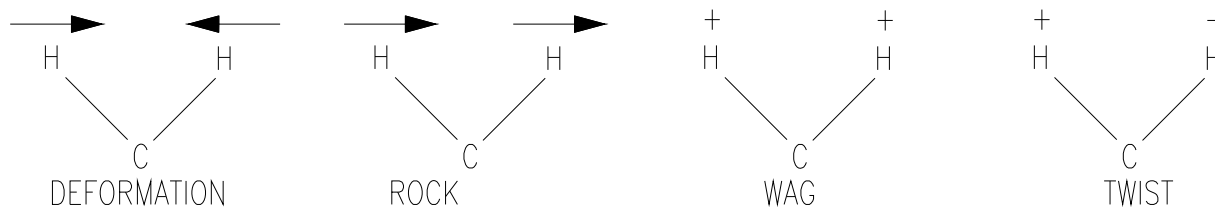

Figure 13-6. Molecular Bending

Three important facts follow from the above:

1. Only the vibrations of a molecule's bonds can absorb infrared energy.
2. There are many possible modes of vibration.
3. Each vibrational mode may correspond to a distinct absorption peak in the infrared spectrum of that molecule.

Resonance

Every object has a natural frequency at which it vibrates. As a sound wave travels through the air, it carries energy with it. This energy is what causes eardrums to vibrate when struck by the wave. In the same manner, a larger, less sensitive object also bends slightly with each compression or rarefaction which hits it. Normally this deformation is so slight that it is not noticeable, but if the frequency of the sound wave just matches the natural frequency of the object struck, the object absorbs part of the sound wave's energy and resonates.

Many people have heard the story of an opera singer's voice shattering a crystal glass. Like molecular bonds, the crystal has tones or harmonics at which it naturally vibrates. At other frequencies it does not vibrate. When an opera singer's voice rises, it eventually hits one of the harmonics of the crystal glass. When it does so, it begins to vibrate (resonate) with the note. It is only at that fundamental tone that it can fully absorb the sound energy. At lower notes the sound energy just passed through the glass without much effect. Similarly, each molecular bond has a characteristic harmonic infrared frequency at which it vibrates. It is only at that particular frequency that the molecular bond can absorb IR energy.

Thus resonance is the key to infrared analysis: If a molecule's bonds vibrate at a particular frequency, wavelengths of infrared radiation are absorbed by those bonds if they are at the same frequency.

For example, if carbon is double bonded to oxygen, it vibrates at a frequency that matches the frequency of infrared energy at a wavelength of 5.8 μm . Whenever molecular frequency matches infrared energy's frequency, that infrared energy is absorbed by the molecules. Molecules of different substances vibrate at different frequencies, and therefore, are responsive to different wavelengths. Because some molecules can be composed of several different atoms, it is also possible that one part of a molecule would absorb at one wavelength, and another part of that molecule at another wavelength. So the total molecule might absorb at multiple wavelengths, because of the many different bond groups on that molecule. One way to tell one molecule from another is by analyzing at different wavelengths of infrared energy.

Chemical bonds can be thought of as tuning forks, each bond naturally tuned to a different pitch or vibrational frequency. If the tuning fork is struck softly, it sounds a particular note. Striking the fork harder does not change the fundamental pitch of the fork. It only vibrates more forcefully and consequently sounds louder. It does not change to a different note. Chemical bonds are like nature's molecular tuning forks.

Summary

- At the atomic and molecular level, all matter, regardless of size or composition, is in constant motion.
- The bonds holding atoms together in molecules can be thought to behave much like a "Slinky" spring. The spring-like wagging, stretching, and bending motions of the bonds are forms of molecular vibration.
- Each molecular bond has a natural frequency associated with each type of vibration.
- Energy can be absorbed by the molecule if the frequency or wavelength of the incident energy matches (resonates with) the natural frequency of one or more of the molecule's bonds.

The whole classification of normal vibrations is quite complex and would require a detailed mathematical treatment that is beyond this document. The main point is that vibrational characteristics of molecules allow us to determine what kind and how much of a molecule is present.

QUALITATIVE ANALYSIS: IDENTIFYING COMPOUNDS

Spectroscopy is the study of how energy (typical electromagnetic energy) interacts with matter. We use selected areas between 1.8 to 14.1 μm band of the electromagnetic spectrum because higher energy levels, such as those used in mass spectrometry, break the molecules down to the atomic or subatomic particle level. While nuclear magnetic resonance and other techniques are useful for determining the atomic properties of molecules, they are not designed for "fingerprinting" molecules and identifying them.

A spectrophotometer is an instrument for recording variations in intensity of electromagnetic radiation at various frequencies. A simple diagram of the functional parts of an infrared spectrophotometer, such as the SapphIRE Analyzer, is shown in Figure 13-7.

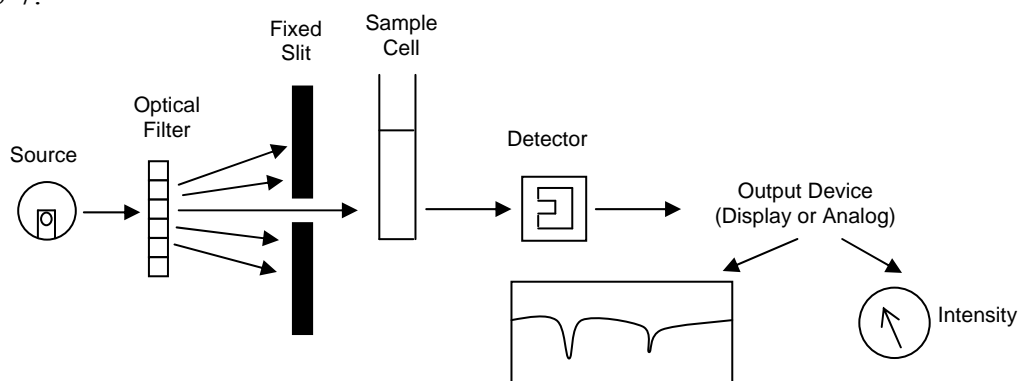

Figure 13-7. Diagram of a Spectrophotometer

Chapter 13 Infrared Spectroscopy Tutorial

In this figure, note the following:

- Source of IR radiation - Heated wire in the SapphIRe Analyzer
- Sample Cell – 0.5 or 12.5 m pathlength cell in the SapphIRe Analyzer
- Optical Filter - permits selection of a single, specific wavelength of IR radiation to reach the detector
- Detector - The pyroelectric, heat-sensitive element used to measure IR energy emerging from the sample cell

In a typical infrared spectrophotometer, a source simultaneously emits all the infrared wavelengths. These wavelengths cover nearly all the natural vibrational frequencies of organic compounds. One of the natural vibrational frequencies of the Tetrahydrofuran (THF) molecule, for example, occurs at about 1064 cm^{-1} (9.40 microns). If all the infrared frequencies are beamed through a sample of THF in the sample cell, some of the radiation at the wavenumber 1064 are absorbed by the THF molecules, whereas most of the other frequencies are transmitted. This absorption can be plotted using a common strip chart recorder to produce an air-referenced spectrum similar to that in (Figure 13-8).

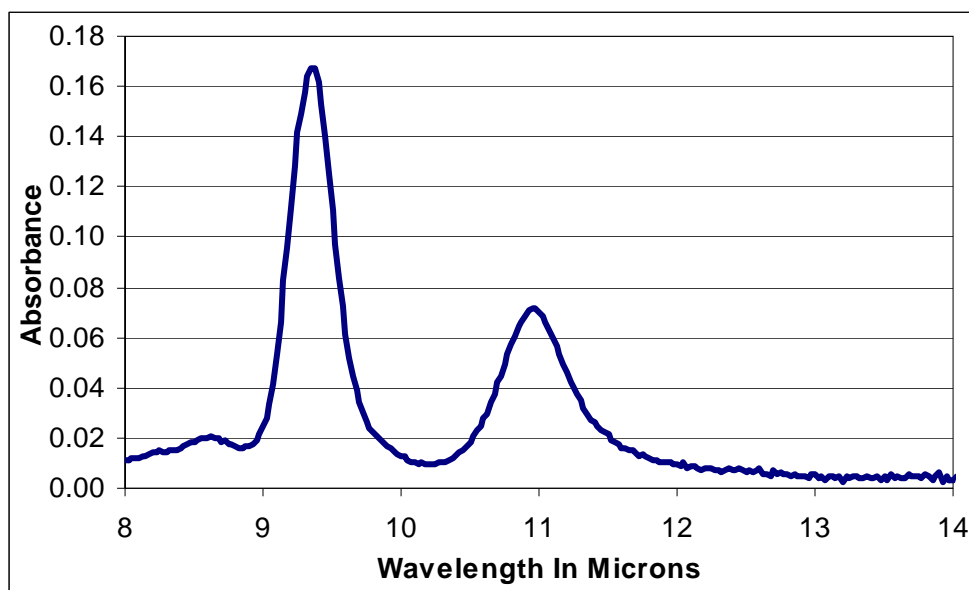

Figure 13-8. Scan of Tetrahydrofuran (THF)

Infrared spectra are specific for the compound analyzed. Like fingerprints, no two are the same. This provides a means for identifying an organic substance.

A typical spectrum is a plot of absorption (or transmission) of infrared energy (radiation) against its wavelength (λ) or wavenumber (ν). As indicated in Figure 13-7, the drive of the optical filter is synchronized with the x-axis of the chart recorder so that the latter indicates the wavelength of radiation reaching the detector via the slit. It is important to note that the SapphIRe Analyzer operates continuous wavelengths from 7.7 to 14.1

microns. The signal from the detector is transmitted to the y-axis of the recorder, indicating how much radiation is absorbed by the sample at a particular wavelength.

Thus, any point on the curve of an absorption spectrum can be characterized by two factors: wavelength and the intensity of IR energy absorption.

Absorption Peaks

The wavelength at which maximum energy absorption occurs is called an absorption peak. It is a narrow band of frequencies of energy strongly absorbed by compounds in a sample cell. The absorption peak's wavelength value is a qualitative measurement. While frequency or wavenumber is often used to indicate this information, wavelength in μm units is also used to identify absorption peaks.

Note: Viewing absorption peak values on spectral charts gives only a rough approximation of the specific values of absorption peaks. Much greater accuracy can be achieved with computer-aided analyzers such as the SapphIRe Analyzer.

If the sample cell were completely clean of any absorbing gases (including air), the absorption spectrum would look like that shown in Figure 13-9).

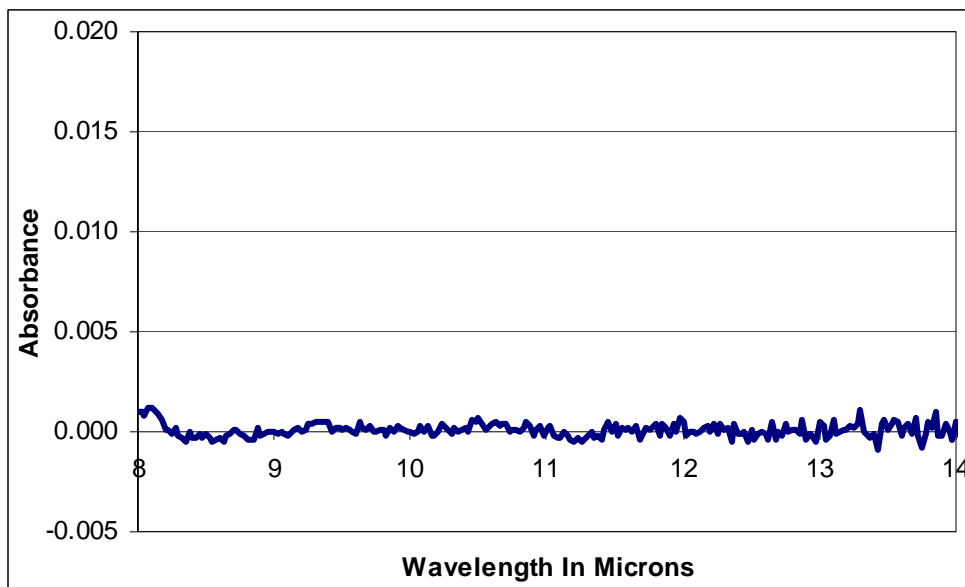

Figure 13-9. Blank Air Reference Scan

Chapter 13 Infrared Spectroscopy Tutorial

Not all absorption spectra are so simple. Most contain multiple peaks. Figure 13-10 is an absorption spectrum of a single organic compound, Isopropanol in air. There are a number of distinct absorption peaks (shown circled). Some peaks contain "shoulders", less intense peaks leading up to the main peak. From this figure, it is obvious that infrared spectra of multiple compounds have many overlapping peaks.

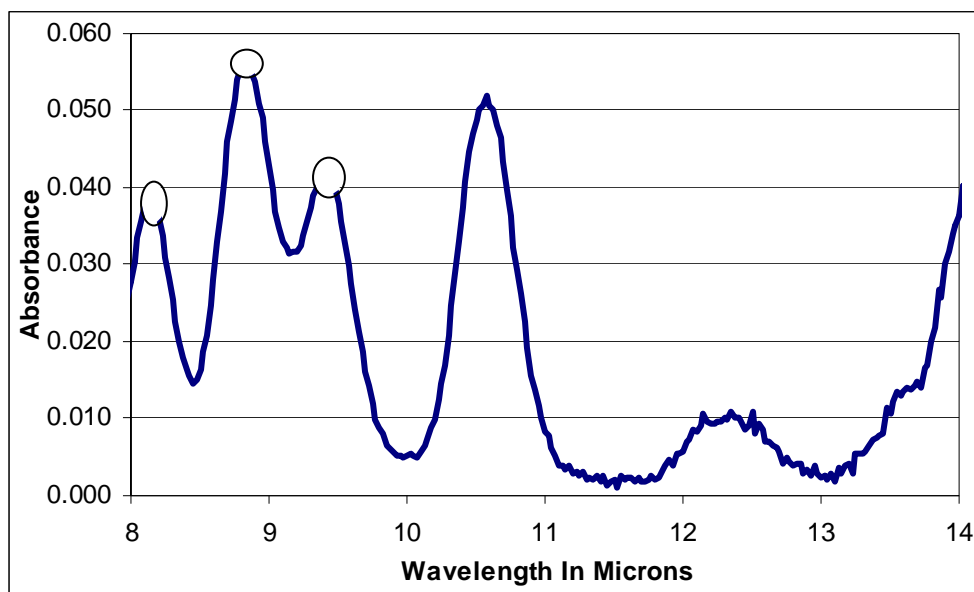

Figure 13-10. Isopropanol in Air With Absorption Peaks Indicated

For example, in the following 10 ppm scan of methylene chloride in ambient air, its characteristic absorption peak at around 13.5 microns is practically obscured at low concentrations by other components in the air (Figure 13-11, upper). Only at higher concentrations or by compensating for other compounds (see second scan at 100 ppm compensated for air) can certain peaks be easily identified (Figure 13-11, lower).

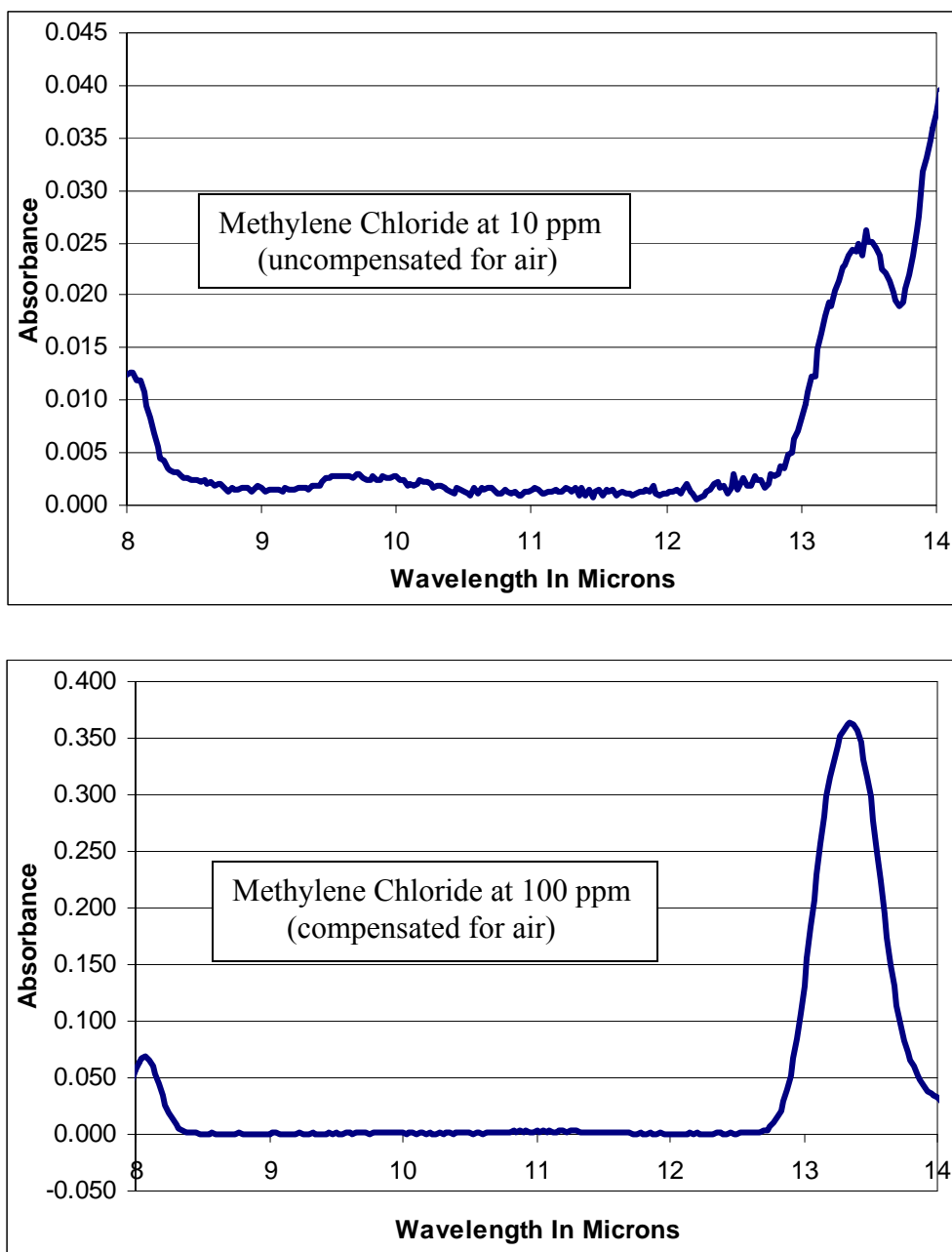

Figure 13-11. Scans of Methylene Chloride

Choosing Analytical Wavelengths of Gas Compounds

From the "fingerprint" or IR spectrum by which a compound is identified, we must choose a good analytical wavelength for a measurement. This is a critical step in performing a gas calibration. By identifying characteristic main and secondary absorption peaks unique for that particular compound and recording them for future reference, a library of analytical wavelengths for a large number of gases can be maintained. The specific analytical wavelength chosen for each organic compound depends upon two factors: specificity and intensity.

Specificity

The wavelength chosen for a particular compound must be characteristic of that compound; it should serve to easily identify and distinguish the compound from other similar compounds. For example, Figure 13-12 shows spectra of two distinctly different hydrocarbons: isopropanol (2-propanol) and methyl ethyl ketone. Absorption peaks in the isopropanol spectrum are present at 8.2, 8.9, and 10.6 microns. Also note that methyl ethyl ketone has peaks close to 8.9 and 10.6 microns but not close to 8.2 microns. Therefore, the 8.2 micron peak serves best at distinguishing isopropanol from methyl ethyl ketone.

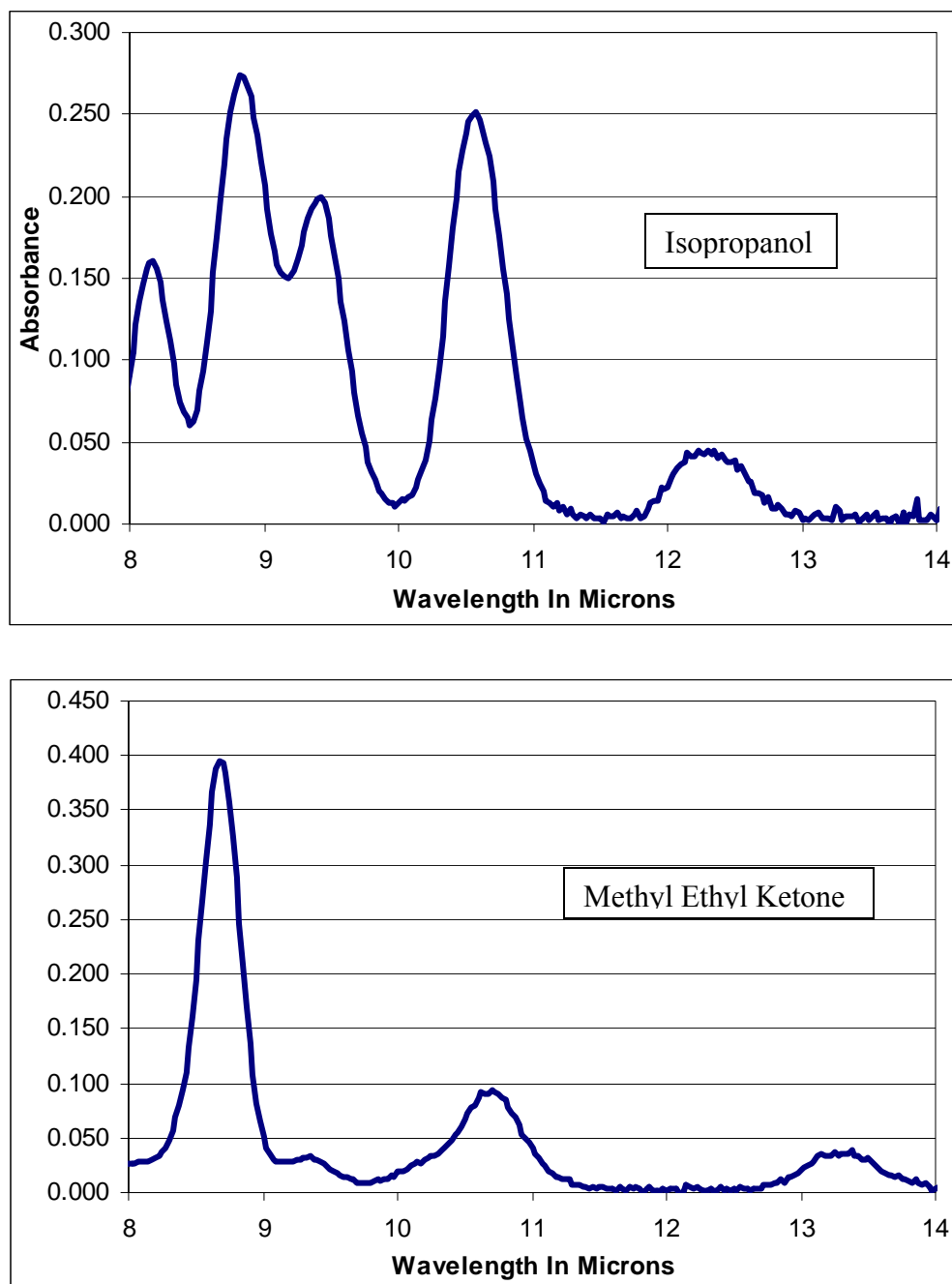

Figure 13-12. Selecting a Distinguishing Peak of a Compound

Intensity

A second important criterion in selecting a wavelength for analysis is that the absorption level must be sufficiently intense to be measurable in the concentration range desired. Figure 13-13 shows two spectra for R-142b at 10 and 120 ppm. Two distinct absorption

Chapter 13 Infrared Spectroscopy Tutorial

peaks present themselves at 8.5 and 10.5 microns . Note that the one at 8.5 microns is strong at both concentrations and that the one at 10.5 microns practically disappears at the concentration of 10 ppm.

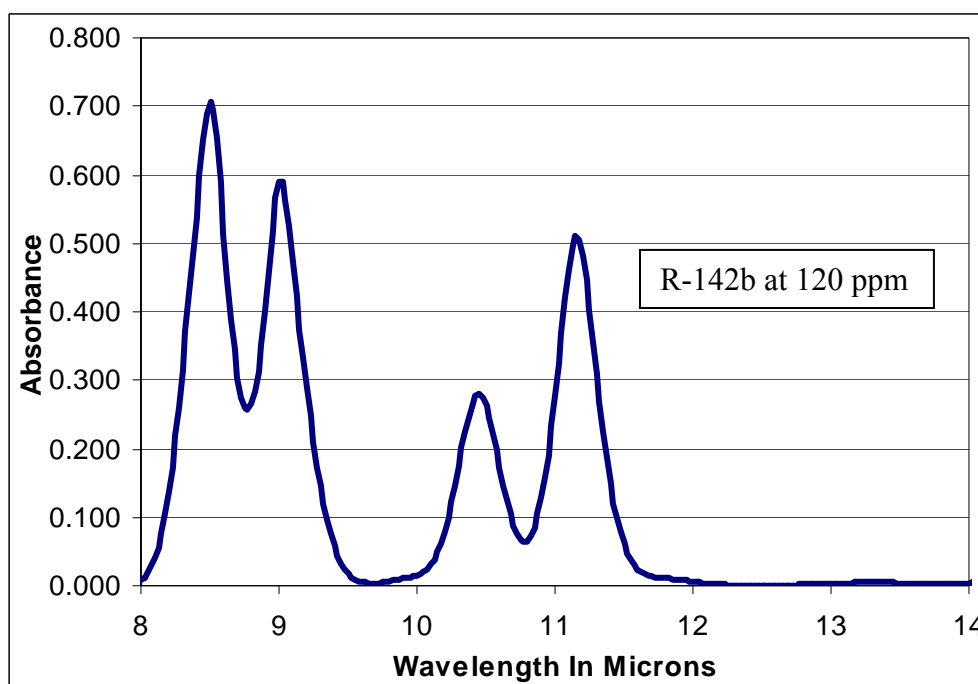
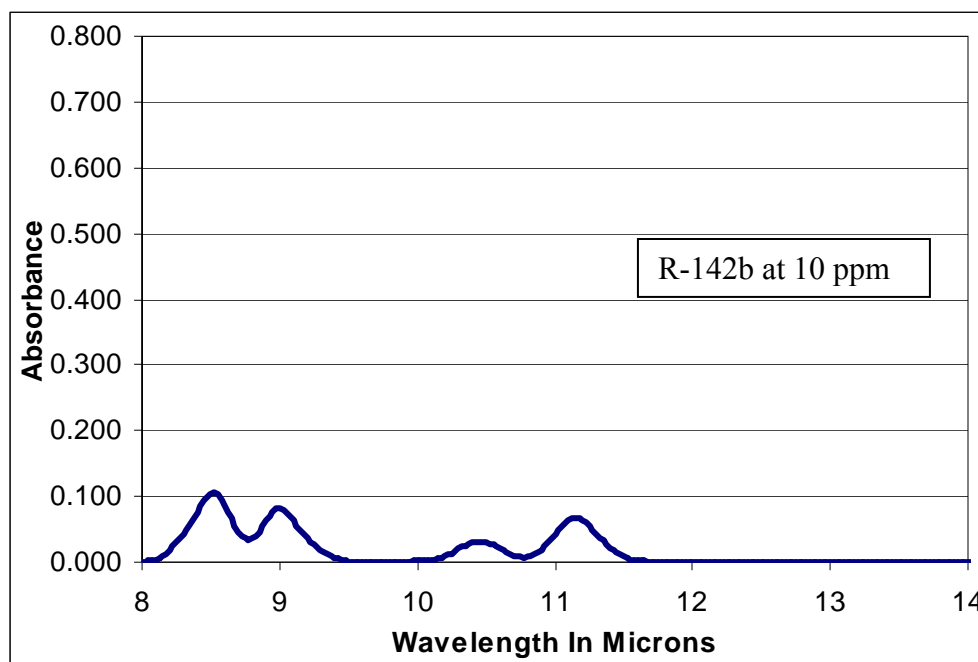

Figure 13-13. Selecting the Peak of High Intensity at Varying Concentrations

QUANTITATIVE ANALYSIS: MEASURING ABSORPTION LEVELS

The previous section showed that the second major characteristic of an absorption peak is the intensity of energy absorption and that the presence and intensity of IR absorption of any given peak varies with the identity of the specific organic compound being analyzed. Absorption also varies with the concentration of gases in the sample cell and with the effective length of the path the infrared beam travels through the sample cell. Generally speaking, the greater the concentration of gases and the longer the pathlength, the greater the absorption of IR energy. Intensity of absorption is typically measured in % Transmittance or in Absorbance Units (AU).

% Transmittance

Almost all chart recorders represent spectra as a plot of % Transmittance on the y-axis vs Frequency and Wavelength on the x-axis. The resulting plot, Figure 13-14, is a measure of how much IR energy has passed through the sample and reached the detector.

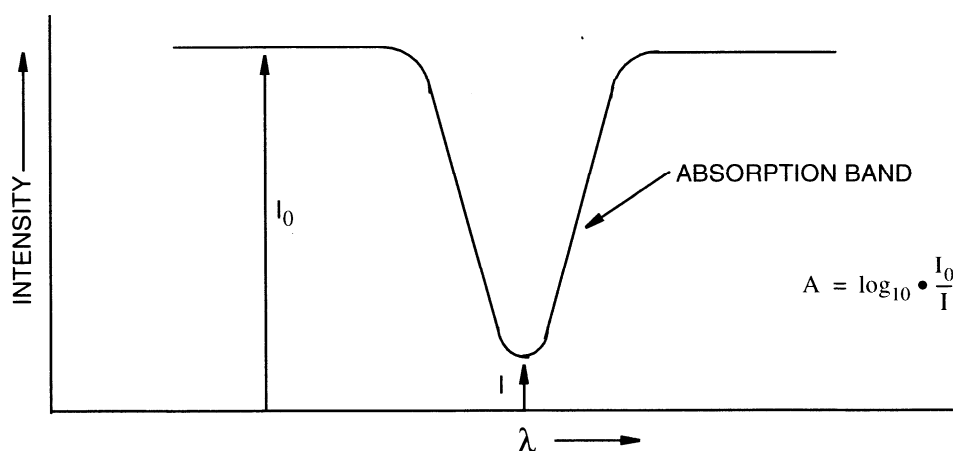

Figure 13-14. Definition of Transmittance and Absorbance

Transmittance is a measure of the difference between incident radiation, I_0 (the intensity of IR energy entering a sample cell) and the transmitted radiation, I (the intensity of IR energy leaving the sample cell and reaching the detector) or $T = I/I_0$. We can therefore express % Transmittance as: $\%T = (I/I_0) \times 100$.

Absorbance Units (AU)

Another convenient way of representing the intensity of absorbance of infrared energy is in Absorbance Units (AU). Like transmittance, absorbance can also be expressed as a ratio in terms of the intensity of incident vs. transmitted IR energy: $A = \log_{10} I_0/I$. Since %T varies exponentially with intensity of transmitted light, a plot of absorbance vs. concentration is linear (Figure 13-15).

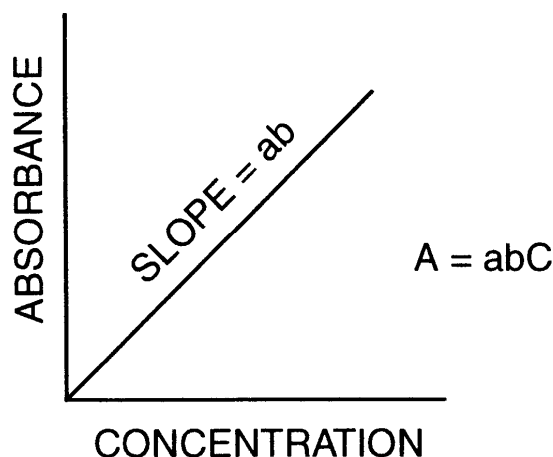

Figure 13-15. Concentration vs. Absorbance

Relation of Transmittance to Absorbance Units

Since both transmittance ($T = I_0/I$) and Absorbance ($A = \log_{10} I_0/I$) are derived from the same proportion of intensity of incident vs. transmitted energy, we can substitute to solve for the value of A in terms of T. This relationship is $A = \log_{10} (1 / T)$. Therefore the absorbance value at 100 % Transmittance is 0.

Summary

- % Transmittance and Absorbance Units are the standard measures for representing the intensity of absorption of IR energy.
- The most accurate calibration readings with the SapphIRe Analyzer are obtained at full scale between 0.2 and 0.6 AU, which represents a 67% - 25% transmittance of IR energy.
- AUs are derived from % Transmittance, a ratio of intensity of IR radiation entering and leaving the sample cell.

THE BEER-LAMBERT LAW

The Beer-Lambert Law (usually referred to as Beer's Law) describes the relationship between absorption and concentration. It states that the amount of energy absorbed at a certain wavelength is directly proportional to the concentration of the sample and to the pathlength over which the energy travels through the sample. $A = kCL$ where:

A is the absorbance of the sample gas. This number represents the amount of IR energy absorbed by the gas molecules in the sample cell.

k is a proportionality constant often known as the absorptivity. It is related to wavelengths absorbed by particular chemicals. At a given wavelength it does not change.

C is a measure of concentration. It represents the quantity of the gas in the sample cell.

L is the pathlength. This is a measure of the distance that the infrared beam must travel in order to pass through the gas in the sample chamber.

Linearity of Absorbance vs. Concentration

At low concentrations, the absorbance of a compound is typically directly proportional to the concentration over the distance the light is allowed to travel through the sample. Therefore, if a sample of HCl at 100 ppm yielded an absorbance of 0.14 AU and the concentration was doubled to 200 ppm, the absorbance value (at the same pathlength) theoretically doubles to 0.28 AU. Also, a plot of absorbance vs. concentration should produce a straight line (Figure 13-16).

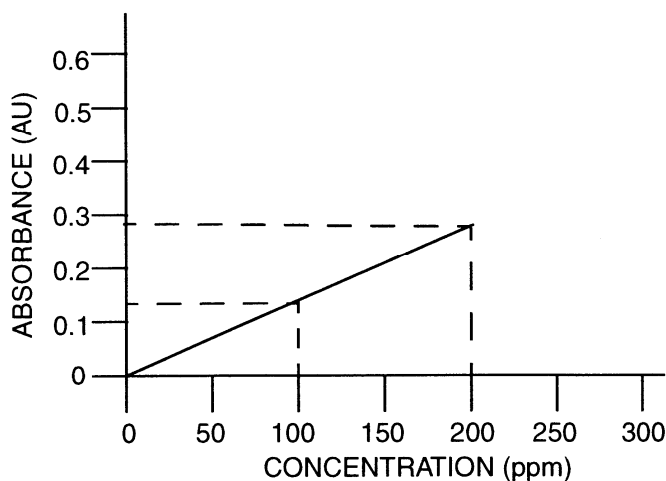

Figure 13-16. Absorbance - Theoretical Concentration Linearity

Deviations from Beer's Law

The previous section discussed Beer's Law in a general way. Figure 13-17, plotting five concentrations of the gas shows that linearity is quite good up to 20 ppm but that above this point the curvature becomes more pronounced.

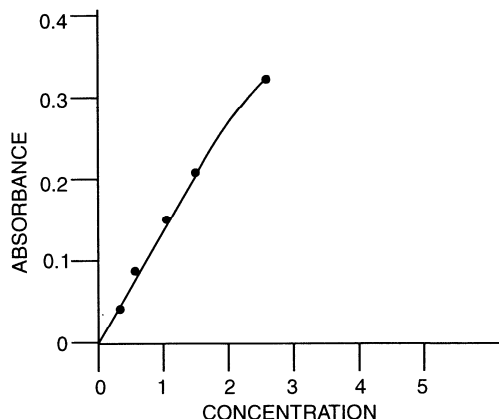

Figure 13-17. Absorbance - Actual Concentration Linearity

The apparent failure of Beer's Law at higher concentrations is most likely due to the interaction of gas molecules with one another in the sample cell. Collisions between molecules as well as polymerization are two phenomena thought to account for deviations from linearity.

The SapphIRe Analyzer is programmed to make appropriate adjustments to Beer's Law at high concentrations of gases in order to compensate for the nonlinear relationship. It does this by including a quadratic term in the formula it uses for deriving concentration levels from absorbance values. For certain gases, it has also been preprogrammed for two ranges of concentration, a high and a low range.

Knowing this about the nonlinearity of Beer's Law at high concentrations, it is important to limit analytical work to the 0 - 1 AU range in order to achieve the highest degree of accuracy using the SapphIRe Analyzer. The ability to alter the pathlength, the effective distance IR radiation travels through the sample cell, provides a convenient method for keeping absorbance values within these recommended limits.

INFRARED SPECTROSCOPY SUMMARY

While there is much more to interpreting IR absorption spectra than presented in this chapter of this instruction, the essential features of IR absorption spectroscopy are as follows:

1. Chemical substances absorb IR radiation selectively at specific frequencies characteristic of the natural vibration of the bonds and the molecular groups comprising the substance. IR radiation at other frequencies is not absorbed. Each compound's pattern of absorption frequencies, its IR spectrum, is unique. Like fingerprints, no two are alike, and thus can be used to identify the molecules in an

unknown sample. By knowing at what wavelengths energy is absorbed, the types of molecules in a compound can be identified.

2. Selecting a good fingerprint for a compound involves finding an intense absorption peak in its IR spectrum at a wavelength where:
 - a. it can easily be identified from among other similar compounds, and
 - b. interference from water and carbon dioxide is minimal.

These practical considerations often mean selecting an alternate analytical wavelength for identifying and measuring the target compound.

3. We can also determine how much of the chemical compound is present using quantitative techniques based on Beer's Law.

When a certain quantity of IR energy is beamed through the sample cell containing molecules of a chemical compound, the molecules absorb a certain percentage of that energy. The amount of energy absorbed can be expressed in % Transmittance or in Absorbance Units.

By knowing how much IR energy is absorbed, we can figure out how many molecules are in the chamber. Very low concentration levels of gases can thus be measured and expressed in parts per million (ppm).

HOW THE SAPPHIRE ANALYZER WORKS

The SapphIRE Analyzer is a single-beam, microprocessor-controlled, infrared analyzer with a variable pathlength gas cell and an optical filter (Figure 13-18). In the analyzer, infrared light is generated by a glowing metal alloy filament (a) heated to a dull orange glow. A rotating chopper blade (b) interrupts and synchronizes the beam so that the intensity of the signal reaching the detector is modulated. The beam then passes through a variable filter (c), to remove extraneous wavelengths of light, into the sample cell (d) containing the gas sample.

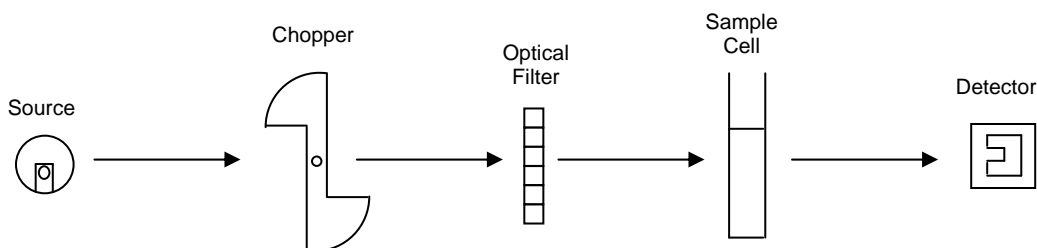

Figure 13-18. Internal Components of the SapphIRE Analyzer

Chapter 13 Infrared Spectroscopy Tutorial

In the cell, the infrared light is reflected back and forth through the sample by gold-coated mirror(s). This folded-pathlength design allows for adjustment of pathlength between 0.5 and 12.5 meters. The greater number of reflections, the more energy is absorbed by the sample before the infrared radiation reaches the detector (e). When the infrared radiation finally impinges on the detector, the energy is converted to an electric signal, which, after amplification and translation into a digital form, appears on the readout display. Concentration values can be presented in concentration or absorbance units.

Gases are brought into the analyzer by means of an air sampling pump at the rate of 14 liters per minute. The need to change the pathlength is prompted by the microprocessor and then the pathlength mechanism must be adjusted manually to 0.5 or 12.5 meters. The adjustment mechanism causes a small rod to press on a mirror inside the cell. By pivoting the angle of the mirror, the number of reflections of light is increased or decreased depending on the direction the mirror is moved.

All analyzers must have a source of infrared radiation. The source in the SapphIRe Analyzer is a metal alloy filament, which, when heated to 825°C, emits a broad spectrum of radiation. The filament's operation is similar to the one used in a regular light bulb except that it produces primarily wavelengths of infrared energy or heat instead of light.

Radiation from the filament passes through revolving blades which interrupt (or chop) the beam and synchronize the electronic circuits with the IR energy reaching the photodetector cell. The beam of energy must be interrupted so that the intensity of IR energy reaching the photodetector constantly varies. Otherwise the detector would rapidly become saturated and insensitive to the IR radiation.

Next, the modulated beam passes through a monochromatic filter made of special glass that allows a narrow band of IR radiation to pass through at any one moment. This infrared linear variable filter is capable of selecting one of seven fixed bandpass filters or individual wavelengths in the range of 7.7 to 14.1 microns (Figure 13-19). This is accomplished by a servo mechanism automatically moving the filter to the correct position. The filter moves between fixed and variable wavelength positions.



Figure 13-19. Linear Variable Filter

Resolution is the ability of the analyzer to use only that wavelength called for by the analysis. The variable filter used in the SapphIRe Analyzer has varying resolution depending on the wavelength range selected (Table 13-1).

Table 13-1. Wavelength Ranges

Wavelength (μm)	Bandwidth (%)	Bandwidth (μm)
General Hydrocarbons 3.333	3.3	0.11
Other Fixed Filters 1.859, 3.573, 4.004, 4.250, 4.500, 4.620	1.5	0.06 at wavelength of 4.0 μm
8.000	2.7	0.22
11.000	2.3	0.25
14.000	2.0	0.28

Resolution becomes very important if two compounds have absorbance close together in the infrared spectrum. When monitoring for one compound, it is important that the peak for the other compound not interfere in the analysis.

The fundamental concepts are the same, whether it is a single beam infrared analyzer such as the SapphIRe Analyzer, or a double-beam laboratory instrument. The major differences between the two types of instruments are portability and resolution. The SapphIRe Analyzer is designed as a portable unit to be used in the field for quantitative work. The design is geared towards a high energy through-put to enable detection of gases and vapors at very low concentration levels (often below 1 ppm).

Chapter 14

Custom Report Formatting

GENERAL

The standard report format for the analyzer includes (Figure 14-1):

- A header containing the product name and model, the date and time of the site report, and the site being reported.
- The gas data
For single sample log: contains the name of the gas, its HRL and concentration unit, the location of the readings, the maximum, minimum, average readings at each date and time along with any alarm flags.

For a continuous type log: contains general statistics and statistics for each gas followed by the information stated immediately above for a single sample log.

For a spectrum scanning log: contains wavelength and absorbance data for region scanned

- A footer containing user entered data (if any).

MIRAN SapphIRe - XL				04Jan01 10:15		
SITE: PLANT A						
ETO						
				HRL: 100.00 ppm		
LOCATION	DATE/TIME	MAX	MIN	AVG	FLAGS	
-----	-----	-----	-----	-----	-----	
AREA1	04Jan01 07:35:17	-0.06	-0.06	-0.06	...	
AREA2	04Jan01 07:36:09	-0.06	-0.07	-0.06	...	
AREA3	04Jan01 07:37:02	-0.07	-0.16	-0.11	...	

Figure 14-1. Sample Standard Report Format

OBTAINING A CUSTOM REPORT

To produce a report with a different format:

1. Create a format with a personal computer by downloading the report format from the analyzer to the PC and modifying it to meet specific needs per this section of the manual.
2. Sketch out the desired format and Thermo Fisher Scientific will create and sell a customized format disk.

Chapter 14 Custom Report Formatting

HEADER

The header appears one time per site. In the coded format, it begins with the words REPORT-HEADER and ends with the word END. The standard entry begins:

```
\*00] ~~~~~-\01] ~~~~~ SITE REPORT\_60~~~~~\!20~~~ \!31~
```

This prints out as MIRAN SapphIRe - (model number) and, after tabbing to column 60, the date, two spaces, and the time.

The easiest way to customize the header is to type the \ and whatever title required in the header. To place other items in the header, tab to a specific column by entering _ and a number (for example, _60) or space to the column to locate the next item. To center something in a field, enter a vertical bar | at the beginning and end of the field. To print the current date and time, enter a code as follows:

Table 14-1. Date and Time Codes

Format	Code
DDMMYY	\!20
DDMMYYYY	\!21
MM/DD/YY	\!22
MM/DD/YYYY	\!23
DD/MM/YY	\!24
DD/MM/YYYY	\!25
HH:MM:SS	\!30
HH:MM	\!31

Thus, the first line of the header might read:

```
\ABC Widget Company\_30Toxic Gas Monitor Report\_60\!20 \!31
```

This would print:

```
ABC Widget Company Toxic Gas Monitor Report 13MAR98 13:45
```

To print the designation of the site configured into the analyzer, enter SITE: *04

If Laboratory C were tested, this would print SITE: Laboratory C

Type END on the next line when the header formatting has been finished.

GAS DATA

The main part of the report is the gas data section. It reports data for each location. In the coded format, it begins with the words GAS DATA and ends with the word END. The standard printed format is shown in Figure 14-1 and the same format as coded in Figure 14-2.

```

REPORT-GAS DATA-SINGLE SAMPLE LOG
~~~~
~~~~
~~~~
~~~~
~~~~
~~~~
      {G |           \@30|~~~           |~~~~~}
~~~~
      {G |           HRL: \@31~~ \#24   |~~~~~}
~~~~
LOCATION      DATE/TIME      {G | MAX      MIN      AVG FLAGS|~~~~~}
-----
{H{D\#15~~~~~ \#00~~~ \#10~~~~~{G \#20~~ \#21~~ \#22~~ \#45\#46\#47 }
}}\
END
    
```

Figure 14-2. Gas Data Standard Coded Format

The coding in Figure 14-2 is explained as follows:

Table 14-2. Codes Used in Standard Format

Code	Meaning
{D}	Repeat for all logged data for a location.
{G}	Repeat for each gas for one location.
{H}	Repeat for all logged locations that are sequential and exactly the same except for the location and data logged.
	Center data within field with leading and trailing spaces.
~	May be ignored; for definition readability/layout only
\@30	Gas name
\@31	Gas High Range Limit
\#00	Date in format DDMMYY
\#10	Time in format HH:MM:SS
\#15	Location
\#20	Maximum Concentration
\#21	Minimum Concentration
\#22	Average Concentration
\#24	Concentration Unit
\#45	Fault Flag
\#46	High Alarm Flag
\#47	Low Alarm Flag

FOOTER

The footer, like the header, appears one time per site. In the coded format, it begins with the words REPORT-FOOTER and ends with the word END. A footer is optional. If it is used, it may be just typed in or coded to insert the notes entered in the REPORT-ENTRY FIELDS section.

REPORT-ENTRY FIELDS

This section of report entry defines the user entered information. It begins with the words REPORT-ENTRY FIELDS and ends with the word END. The report entry fields is in the format: nn t sz r pppppppppp« where:

nn =Field number, valid range 01-30, 2 digits, right justified, leading zeros, duplicate values result in error, entries beyond the maximum entry defined in list are not presented for entry.

t = Type of entry field

A = Alphanumeric value, initial value is none

= Numeric value (numbers, period, and minus sign only), initial value is none

D = Date value, DDMMYY format, numbers for DD and YY, letters for MMM, initial value is current date

d = Date value, nn/nn/nnnn format, numbers only, initial value is current date

T = Time value, hh:mm:ss format, numbers only, initial value is current time

t = Time value, hh:mm format, numbers only, initial value is current time

- = Not used (for formatting entry screens)

sz =Number of characters in entry, valid range 00-12, 2 digits, right justified, leading zeros, size must be 00 for unused entry types, size must be ≥ 00 for all other types

r = Field reset on new type switch

0 = Field is reset when starting new site

1 = Field is not changed when entering a new site

p = Prompt name, 1 to 9 characters, for names less than the maximum allowed characters terminate with an early «, field ignored for undefined entry type

Example:

REPORT-ENTRY FIELDS

01	#	10	0	SITE NAME«
02	A	12	0	LAST NAME«
03	A	12	0	1ST NAME«
04	A	12	0	ADDRESS 1«
05	A	12	0	ADDRESS 2«
06	A	12	0	ADDRESS 3«
07	#	05	0	SQ FEET«
08	d	08	0	DATE«
09	t	05	0	TIME«
10	-	00	0«	
11	-	00	0«	
12	-	00	0«	
13	A	01	0	SUNNY«
14	A	01	0	CLOUDY«
15	A	01	0	RAINING«
16	A	02	0	WIND DIR«
17	-	00	0«	
18	-	00	0«	
19	A	12	1	USER NAME«
20	A	12	1	UNIT NAME«
21	-	00	0«	
22	-	00	0«	
23	-	00	0«	
24	-	00	0«	

CODING GUIDE

This guide specifies the selection and designation of the various entry and data fields available for insertion in the report. Report generation replaces each field designator with the associated characters as defined herein.

Field Designator Specification Overview

The field designator is in the format \ANNF where:

\	=	Start of field designator
A	=	the type of field
!	=	Special functions
+	=	Set general purpose index
-	=	Tab to column
\$	=	User entries
*	=	General configuration information
@	=	Application data
#	=	Measurement data
S	=	Measurement statistics
NN	=	the field number (2 digits, right justified, leading zeros)
F	=	an optional format modifier
.	=	Normal formatting
<	=	Left justify data within field with trailing spaces
>	=	Right justify data within field with trailing spaces
	=	Center data within field with leading and trailing spaces
[=	Do not output spaces from the last nonspace character in the field to the end of the field (shorten unused field characters)
]	=	Do not output spaces from the first field character to the first nonspace character in the field
=	=	Same as both < and >

Looping Indicators

Certain data within the report output may be repeated by surrounding the repeated characters in the definition with braces "{}" and indicating a looping type. The looping type is specified by the letter D, G, H, or W immediately following the starting brace "{." The braces and looping type are not output in the report. Loop nesting is allowed to a depth of at least 3. The following repeat loops are provided.

{D	Repeat all the logged data for a location
{G	Reset the General Purpose Index, increment and repeat for all gases
{H	Repeat for all logged locations that are sequential and exactly the same except for the location and the data logged.
{W	Reset the General Purpose Index, increment and repeat for all wavelengths

Special Characters

Certain characters have a special meaning:

- ~ For definition readability/layout only; may be ignored
- \« Terminate format definition line processing, move to next line

Field Designator Specification Details

Field Designator ! (Special Functions)

00: Form Feed

Description: Form feed character
When Valid: Always
Character size: 1
Format: Not applicable

01: General Purpose Index

Description: Value of the general purpose index
When Valid: Always
Character size: 2
Format: NN, right justified, leading spaces

02 to 19: Reserved

Description: Reserved for future use
When Valid: Never
Character size: Not applicable
Format: Not applicable

20: Current Date - DDMMYY Description: Current date

When Valid: Always
Character size: 7
Format: DDMMYY
" - - - ", Undefined

21: Current Date - DDMMYYYY

Description: Current date
When Valid: Always
Character size: 9
Format: DDMMYYYY
" - - - ", Undefined

22: Current Date - MM/DD/YY

Description: Current date
When Valid: Always
Character size: 8
Format: MM/DD/YY
" - - - ", Undefined

23: Current Date - MM/DD/YYYY

Description: Current date
When Valid: Always
Character size: 10
Format: MM/DD/YYYY
" - - - ", Undefined

24: Current Date -DD/MM/YY

Description: Current date
When Valid: Always
Character size: 8
Format: DD/MM/YY
" - - - ", Undefined

25: Current Date - DD/MM/YYYY

Description: Current date
When Valid: Always
Character size: 10
Format: DD/MM/YYYY
" - - - ", Undefined

26 to 29: Reserved

Description: Reserved for future use
When Valid: Never
Character size: Not applicable
Format: Not applicable

30: Current Time-Seconds

Description: Current time
When Valid: Always
Character size: 8
Format: HH:MM:SS
" - - - ", Undefined

31: Current Time-Minutes

Description: Current time
 When Valid: Always
 Character size: 5
 Format: HH:MM
 " - - - ", Undefined

32 to 99: Reserved

Description: Reserved for future use
 When Valid: Never
 Character size: Not applicable
 Format: Not applicable

Field Designator + (Set General Purpose Index)

00 to 99: Index Set

Description: Set the index used by various other field designators, such as gas index and wavelength index
 When Valid: Always
 Character size: 0, does not generate output characters
 Format: Not applicable

Field Designator _ (Tab)

00 to 99: Tab

Description: Output spaces until reaching or exceeding the column number specified
 When Valid: Always
 Character size: 0 to 99
 Format: Not applicable

Field Designator \$ (User Entries)

00 to 99: User Entered Characters

Description: Alphanumeric characters entered by the user
 When Valid: Always
 Character size: 12 max but may be decreased to 1 by users report
 Format: Left justified, trailing spaces
 All "-" if entry undefined
 '-', Entry size = 0

Field Designator * (General Information)

00: Product Name

Description: Product name from configuration, alphanumeric
When Valid: Always
Character size: 15
Format: Left justified, trailing spaces

01: Product Model

Description: Product model from configuration, alphanumeric
When Valid: Always
Character size: 15
Format: Left justified, trailing spaces

02: Serial Number

Description: Serial number, alphanumeric
When Valid: Always
Character size: 15
Format: Left justified, trailing spaces

03: Firmware Version

Description: Firmware version, alphanumeric
When Valid: Always
Character size: 15
Format: Left justified, trailing spaces

04: Site Name

Description: User entered site name
When Valid: Always
Character size: 12
Format: Left justified, trailing spaces
"<none>" , No site name entered

05: Logging Mode

Description: Logging Mode
When Valid: Always, but may change if value changed during site, initially value when reset for new site
Character size: 13
Format: "Off" , No logging
"Single sample" , One sample per location
"Continuous" , Continuous sampling of a location

06: Logging Interval

Description: The time interval sampled for one logged data point
When Valid: Always, but may change if value changed during site, initially value when reset for new site
Character size: 11
Format: "N DDDDDDD ", Duration, N=0-9
"NN DDDDDDD ", Duration, NN=10-99
"NNN DDDDDDD", Duration NNN=100-999
DDDDDDD = Duration unit
"cycles "
"seconds"
"minutes"
"hours "

07: Reference Compensation Enable

Description: Indicates whether reference compensation is enabled for applications supporting the compensations
When Valid: Always, but may change if value changed during site, initially value when reset for new site
Character size: 1
Format: "x", Enabled
"-", Disabled

08: Humidity Compensation Enable

Description: Indicates whether humidity compensation is enabled for applications supporting the compensations
When Valid: Always, but may change if value changed during site, initially value when reset for new site
Character size: 1
Format: "x", Enabled
"-", Disabled

09: Temperature Compensation Enable

Description: Indicates whether temperature compensation is enabled for applications supporting the compensations
When Valid: Always, but may change if value changed during site, initially value when reset for new site
Character size: 1
Format: "x", Enabled
"-", Disabled

10: Pressure Compensation Enable

Description: Indicates whether pressure compensation is enabled for applications supporting the compensations

When Valid: Always, but may change if value changed during site, initially value when reset for new site

Character size: 1

Format: "X", Enabled
"-", Disabled

11: High Concentration Alarm Enable

Description: Indicates whether the high concentration alarm is enabled for applications supporting the alarm

When Valid: Always, but may change if value changed during site, initially value when reset for new site

Character size: 1

Format: "X", Enabled
"-", Disabled

12: Low Concentration Alarm Enable

Description: Indicates whether the low concentration alarm is enabled for applications supporting the alarm

When Valid: Always, but may change if value changed during site, initially value when reset for new site

Character size: 1

Format: "X", Enabled
"-", Disabled

13: STEL Concentration Alarm Enable

Description: Indicates whether the STEL concentration alarm is enabled for applications supporting the alarm

When Valid: Always, but may change if value changed during site, initially value when reset for new site

Character size: 1

Format: "X", Enabled
"-", Disabled

14: High Concentration Alarm Latched

Description: Indicates whether the high concentration alarm is enabled and latched for applications supporting the alarm

When Valid: Always, but may change if value changed during site, initially value when reset for new site

Character size: 1

Format: "X", Enabled
"-", Disabled

15: Low Concentration Alarm Latched

Description: Indicates whether the low concentration alarm is enabled and latched for applications supporting the alarm
When Valid: Always, but may change if value changed during site, initially value when reset for new site
Character size: 1
Format: "X", Enabled
"-", Disabled

16: STEL Concentration Alarm Latched

Description: Indicates whether the STEL concentration alarm is enabled and latched for applications supporting the alarm
When Valid: Always, but may change if value changed during site, initially value when reset for new site
Character size: 1
Format: "X", Enabled
"-", Disabled

17: Log On Alarm Only

Description: Indicates whether the logging on alarm only is active
When Valid: Always, but may change if value changed during site, initially value when reset for new site
Character size: 1
Format: "X", Enabled
"-", Disabled

18 to 99: Reserved

Description: Reserved for future use
When Valid: Never
Character size: Not applicable
Format: Not applicable

Field Designator @ (Application Data)

00: Application Primary Name

Description: Primary name of application
When Valid: Always, but may change if application changed during site, initially value when reset for new site
Character size: 12
Format: Left justified, trailing spaces
" - - - ", undefined

01: Application Secondary Name

Description: Secondary name of application
When Valid: Always, but may change if application changed during site, initially value when reset for new site
Character size: 12
Format: Left justified, trailing spaces
" - - - ", undefined

02: Application Type

Description: Type of application
When Valid: Always, but may change if application changed during site, initially value when reset for new site
Character size: 10
Format: Left justified, trailing spaces
"Single Gas", Single gas, single analytical wavelength
"Multi-gas ", Multi-gas, multi-analytical wavelength
"Scan ", Spectrum scan
" - - - ", Undefined

03 to 29: Reserved

Description: Reserved for future use
When Valid: Never
Character size: Not applicable
Format: Not applicable

30: Application Gas Name

Description: Application gas name of gas specified by the current General Purpose Index (see previous section)
When Valid: Always, but may change if application changed during site, initially value when reset for new site
Character size: 8
Format: Left justified, trailing spaces
" - - - ", Undefined or 0 length

31: Application Gas High Range Limit

Description: Application gas high range limit of gas specified by the current General Purpose Index (see previous section)
When Valid: Always, but may change if application changed during site, initially value when reset for new site
Character size: 6
Format: Concentration based on active unit, right justified, leading spaces

32: Application Gas High Alarm Limit

Description: Application gas high alarm limit of gas specified by the current General Purpose Index (see previous section)
When Valid: Always, but may change if application changed during site, initially value when reset for new site
Character size: 6
Format: Concentration based on active unit, right justified, leading spaces

33: Application Gas Low Alarm Limit

Description: Application gas low alarm limit of gas specified by the current General Purpose Index (see previous section)
When Valid: Always, but may change if application changed during site, initially value when reset for new site
Character size: 6
Format: Concentration based on active unit, right justified, leading spaces

34: Application Gas STEL Alarm Limit

Description: Application gas STEL alarm limit of gas specified by the current General Purpose Index (see previous section)
When Valid: Always, but may change if application changed during site, initially value when reset for new site
Character size: 6
Format: Concentration based on active unit, right justified, leading spaces

35: Application Gas STEL Time

Description: Application gas STEL time of gas specified by the current General Purpose Index (see previous section)
When Valid: Always, but may change if application changed during site, initially value when reset for new site
Character size: 10
Format: Left justified, trailing spaces
"Off ", STEL off
"5 minutes ", 5 minute STEL
"10 minutes ", 10 minute STEL
"15 minutes ", 15 minute STEL

36: Application Gas Group TWA Weight

Description: Application gas group TWA weight of gas specified by the current General Purpose Index (see previous section)
When Valid: Always, but may change if application changed during site, initially value when reset for new site
Character size: 6
Format: Integer, right justified, leading spaces

03 to 29: Reserved

Description: Reserved for future use
When Valid: Never
Character size: Not applicable
Format: Not applicable

Field Designator # (Measurement Data)

00: Measurement Data - Date-DDMMYY

Description: Date measurement logged
When Valid: When data logged for site, initially first value logged for a site
Character size: 7
Format: DDMMYY
" - - - ", undefined

01: Measurement Data - Date-DDMMYYYY

Description: Date measurement logged
When Valid: When data logged for site, initially first value logged for a site
Character size: 9
Format: DDMMYYYY
" - - - ", undefined

02: Measurement Data - Date-MM/DD/YY

Description: Date measurement logged
When Valid: When data logged for site, initially first value logged for a site
Character size: 8
Format: MM/DD/YY
" - - - ", undefined

03: Measurement Data - Date-MM/DD/YYYY

Description: Date measurement logged
When Valid: When data logged for site, initially first value logged for a site
Character size: 10
Format: MM/DD/YYYY
" - - - ", undefined

04: Measurement Data - Date-DD/MM/YY

Description: Date measurement logged
When Valid: When data logged for site, initially first value logged for a site
Character size: 8
Format: DD/MM/YY
" - - - ", undefined

05: Measurement Data - Date-DD/MM/YYYY

Description: Date measurement logged
When Valid: When data logged for site, initially first value logged for a site
Character size: 10
Format: DD/MM/YYYY
" - - - ", undefined

06 to 09: Reserved

Description: Reserved for future use
When Valid: Never
Character size: Not applicable
Format: Not applicable

10: Measurement Data - Time-Seconds

Description: Time measurement logged
When Valid: When data logged for site, initially first value logged for a site
Character size: 8
Format: HH:MM:SS
" - - - ", undefined

11: Measurement Data - Time-Minutes

Description: Time measurement logged
When Valid: When data logged for site, initially first value logged for a site
Character size: 5
Format: HH:MM
" - - - ", undefined

12 to 14: Reserved

Description: Reserved for future use
When Valid: Never
Character size: Not applicable
Format: Not applicable

15: Measurement Data - Location

Description: Location of logged data
When Valid: When data logged for site, initially first value logged for a site
Character size: 12
Format: Left justified, trailing spaces

16: Measurement Data - Temperature-Degrees C

Description: Logged sample temperature
When Valid: When data logged for site, initially first value logged for a site
Character size: 6
Format: XXX.XC, right justified, leading spaces
" - - - ", undefined

17: Measurement Data - Temperature-Degrees F

Description: Logged sample temperature
When Valid: When data logged for site, initially first value logged for a site
Character size: 6
Format: XXX.XF, right justified, leading spaces
" - - - ", undefined

18: Measurement Data - Wavelength Position

Description: Wavelength in micrometers for the wavelength specified by the current General Purpose Index (see previous section)
When Valid: When data logged for site, initially first value logged for a site
Character size: 6
Format: Wavelength, floating point format=XX.XXX
Right justified, leading spaces
" - - - ", undefined

19: Measurement Data - Wavelength Absorbance

Description: Absorbance for the wavelength specified by the current General Purpose Index (see previous section)
When Valid: When data logged for site, initially first value logged for a site
Character size: 7
Format: Right justified, leading spaces
" - - - ", undefined

20: Measurement Data - Concentration Max

Description: Maximum concentration measured during the data logging interval for the gas specified by the current General Purpose Index (see previous section)
When Valid: When data logged for site, initially first value logged for a site
Character size: 6
Format: Right justified, leading spaces
" - - - ", undefined

21: Measurement Data - Concentration Min

Description: Minimum concentration measured during the data logging interval for the gas specified by the current General Purpose Index (see previous section)

When Valid: When data logged for site, initially first value logged for a site

Character size: 6

Format: Right justified, leading spaces
" - - - ", undefined

22: Measurement Data - Concentration Avg

Description: Average concentration measured during the data logging interval for the gas specified by the current General Purpose Index (see previous section)

When Valid: When data logged for site, initially first value logged for a site

Character size: 6

Format: Right justified, leading spaces
" - - - ", undefined

23: Measurement Data - Concentration STEL

Description: Maximum STEL concentration measured during the data logging interval for the gas specified by the current General Purpose Index (see previous section)

When Valid: When data logged for site, initially first value logged for a site

Character size: 6

Format: Right justified, leading spaces
" - - - ", undefined

24: Measurement Data - Concentration Unit

Description: Concentration units active during the data logging interval

When Valid: When data logged for site, initially first value logged for a site

Character size: 3

Format: Left justified, trailing spaces
" - - - ", undefined
"ppb", ppb
"ppm", ppm
"% ", Percent
"mgm", mg/m³

25 to 39: Reserved

Description: Reserved for future use

When Valid: Never

Character size: Not applicable

Format: Not applicable

40: Measurement Data - Validity Flags-Okay/Fault/Alarm

Description: Concentration validity flags measured during the data logging interval

When Valid: When data logged for site, initially first value logged for a site

Character size: 15

Format: Left justified, trailing spaces

" - - -	", undefined
"OKAY	", No fault or alarm detected
"FAULT	", Fault detected, but no alarm
"HIGH_ALARM	", High alarm only detected, no fault
"LOW_ALARM	", Low alarm only detected, no fault
"STEL_ALARM	", STEL alarm only detected, no fault
"HIGH&STEL_ALARM"	", High and STEL alarm detected, no fault
"LOW&STEL_ALARM "	", Low and STEL alarm detected, no fault
"FAULT&HIGH_ALRM"	", Fault and high alarm detected
"FAULT&LOW_ALARM"	", Fault and low alarm detected
"FAULT&STEL_ALRM"	", Fault and STEL alarm detected
"FAULT&HIGH&STEL"	", Fault and high and STEL alarm detected
"FAULT&LOW&STEL "	", Fault and low and STEL alarm detected

41: Measurement Data - Validity Flags-Clear/Fault/Alarm

Description: Concentration validity flags measured during the data logging interval

When Valid: When data logged for site, initially first value logged for a site

Character size: 15

Format: Same as Okay/Fault/Alarm but replace with following:

"CLEAR	", No fault or alarm detected
--------	-------------------------------

42: Measurement Data - Validity Flags-Okay/First Flag

Description: Concentration validity flags measured during the data logging interval

When Valid: When data logged for site, initially first value logged for a site

Character size: 15

Format: Left justified, trailing spaces

FFFFFFFFFFFFMMM, where:
FFFFFFFFFFFF = Flag:

" - - -	", undefined
"OKAY	", No fault or alarm detected
"NNNNNNNNNNNNNNNN"	", First active flag name, left justified, trailing spaces suppressed
MMM = More flags indicator	
" "	", <=1 flag active
"- - - "	", >1 flag active

43: Measurement Data - Validity Flags-Okay/All Flags Without CrLf

Description: Concentration validity flags measured during the data logging interval

When Valid: When data logged for site, initially first value logged for a site

Character size: 12 to 416 max

Format: Outputs all active flags separated by a '+' (note no separation character after last flag), each flag name is left justified, trailing spaces suppressed, or:
" - - - ", undefined
"OKAY ", No flags active

44: Measurement Data - Validity Flags-/Fault

Description: Concentration validity flags measured during the data logging interval

When Valid: When data logged for site, initially first value logged for a site

Character size: 12 to 448 max

Format: Same as "Validity Flags-Okay/All Flags Without CrLf" but a <CR><LF> separates each flag (note no <CR><LF> after last flag)

45: Measurement Data - Validity Flags-Okay/All Flags Without CrLf

Description: Concentration validity flags measured during the data logging interval

When Valid: When data logged for site, initially first value logged for a site

Character size: 1

Format: Measurement fault flags in order of display precedence:
". ", no measurement fault
"x", Fault
" ", A/D overflow
"}", Calculation overflow
{", Calculation underflow
>", HRL overflow
"v", A/D underflow
"Z", Zero invalid
"P", Purge invalid

46: Measurement Data - Validity Flags-./Alarm High

Description: Concentration validity flags measured during the data logging interval

When Valid: When data logged for site, initially first value logged for a site

Character size: 1

Format: Measurement high alarm flag
"-", Undefined
".", No measurement alarm
"H", High alarm active

47: Measurement Data - Validity Flags-./Alarm Low

Description: Concentration validity flags measured during the data logging interval

When Valid: When data logged for site, initially first value logged for a site

Character size: 1

Format: Measurement low alarm flag
"-", Undefined
".", No measurement alarm
"L", High alarm active

48: Measurement Data - Validity Flags-./Alarm High & Low

Description: Concentration validity flags measured during the data logging interval

When Valid: When data logged for site, initially first value logged for a site

Character size: 1

Format: Measurement high and low alarm flag
"-", Undefined
".", No measurement alarm
"H", High alarm active
"L", Low alarm active

49: Measurement Data - Validity Flags-./Alarm STEL

Description: Concentration validity flags measured during the data logging interval

When Valid: When data logged for site, initially first value logged for a site

Character size: 1

Format: Measurement STEL alarm flag
"-", Undefined
" ", No measurement alarm
"S", High alarm active

50 to 99: Reserved

Description: Reserved for future use

When Valid: Never

Character size: Not applicable

Format: Not applicable

Field Designator S (Measurement Statistics)

Measurement Statistics Format

```

1           2           3           4           5           6           7
01234567890123456789012345678901234567890123456789012345678901234567890
00: LOG RUN STATISTICS«
01: -----«
02: START: DDDDDDDDDD TTTTTTTT«
03: STOP: DDDDDDDDDD TTTTTTTT«
04: «
05: «
06: GGGGGGGG:
07:           CONCENTRATION      DATE/TIME                VALIDITY«
08:           -----            -----            -----«
09: STEL MAXIMUM:   XXXXXX UUU      DDDDDDDDDD TTTTTTTT      VVV...«
10: MAXIMUM:       XXXXXX UUU      DDDDDDDDDD TTTTTTTT      VVV...«
11: MINIMUM        XXXXXX UUU      DDDDDDDDDD TTTTTTTT      VVV...«
12: AVERAGE:      XXXXXX UUU      DDDDDDDDDD TTTTTTTT      VVV...«

```

Lines 4 through 12 repeated for each gas.

where:

GGGGGGGG = Gas name, left justified, trailing suppressed

DDDDDDDDDD = Date format as controlled by designators, default DDMMYY, left justified trailing spaces

TTTTTTTTT = Time format as controlled by designators, default HH:MM:SS, left justified trailing spaces

XXXXXXX = Concentration

UUU = Concentration units

"ppb"

"ppm"

"% "

"mgm"

VVV = Validity format as controlled by designators, default Okay/Fault/Alarm

00 to 19: Measurement Statistics - Line 0 to 19

Description: Generate measurement statistics line as specified by field designator index

When Valid: When continuous data logged for site location, initially first value logged for a site, either valid or invalid depending on logging mode

Character size: 0 to 256 as required

Format: See above

20: Measurement Statistics - Date-DDMMYY

Description: Select format for date in statistics
When Valid: Last designator encountered is used
Character size: 0
Format: DDMMYY
" - - - ", undefined

21: Measurement Statistics - Date-DDMMYYYY

Description: Select format for date in statistics
When Valid: Last designator encountered is used
Character size: 0
Format: DDMMYYYY
" - - - ", undefined

22: Measurement Statistics - Date-MM/DD/YY

Description: Select format for date in statistics
When Valid: Last designator encountered is used
Character size: 0
Format: MM/DD/YY
" - - - ", undefined

23: Measurement Statistics - Date-MM/DD/YYYY

Description: Select format for date in statistics
When Valid: Last designator encountered is used
Character size: 0
Format: MM/DD/YYYY
" - - - ", undefined

24: Measurement Statistics - Date-DD/MM/YY

Description: Select format for date in statistics
When Valid: Last designator encountered is used
Character size: 0
Format: DD/MM/YY
" - - - ", undefined

25: Measurement Statistics - Date-DD/MM/YYYY

Description: Select format for date in statistics
When Valid: Last designator encountered is used
Character size: 0
Format: DD/MM/YYYY
" - - - ", undefined

26 to 29: Reserved

Description: Reserved for future use
When Valid: Never
Character size: Not applicable
Format: Not applicable

30: Measurement Statistics - Time Format Seconds Switch

Description: Select format for time in statistics
When Valid: Last designator encountered is used
Character size: 0
Format: HH:MM:SS
" - - - ", undefined

31: Measurement Data - Time Format Seconds Switch

Description: Select format for time in statistics
When Valid: Last designator encountered is used
Character size: 0
Format: HH:MM
" - - - ", undefined

32 to 39: Reserved

Description: Reserved for future use
When Valid: Never
Character size: Not applicable
Format: Not applicable

40: Measurement Statistics - Validity Flags Format-Okay/Fault/Alarm

Description: Select format for validity flags in statistics
When Valid: Last designator encountered is used
Character size: 0
Format: See Measurement Data - Validity Flags-Okay/Fault Alarm in previous section

41: Measurement Statistics - Validity Flags Format-Clear/Fault/Alarm

Description: Select format for validity flags in statistics
When Valid: Last designator encountered is used
Character size: 0
Format: See Measurement Data - Validity Flags-Clear/Fault Alarm in previous section

42: Measurement Statistics - Validity Flags Format-Okay/First Flag

Description: Select format for validity flags in statistics
When Valid: Last designator encountered is used
Character size: 0
Format: See Measurement Data - Validity Flags-Okay/First Flag in previous section

43: Measurement Statistics - Validity Flags Format-Okay/All Flags Without CrLf

Description: Select format for validity flags in statistics
When Valid: Last designator encountered is used
Character size: 0
Format: See Measurement Data - Validity Flags-Okay/All Flags Without CrLf in previous section

44: Measurement Statistics - Validity Flags Format-Okay/All Flags With CrLf

Description: Select format for validity flags in statistics
When Valid: Last designator encountered is used
Character size: 0
Format: See Measurement Data - Validity Flags-Okay/All Flags With CrLf in previous section

45 to 49: Reserved

Description: Reserved for future use
When Valid: Never
Character size: Not applicable
Format: Not applicable

50: Measurement Statistics - Start and Stop Date/Time Off

Description: Turns off lines displaying start and stop date/times
When Valid: Last designator encountered is used
Character size: 0
Format: Not applicable

51: Measurement Statistics - Measurement Date Off

Description: Suppresses columns and trailing separated spaces associated with concentration dates, including header lines
When Valid: Last designator encountered is used
Character size: 0
Format: Not applicable

52: Measurement Statistics - Measurement Time Off

Description: Suppresses columns and trailing separated spaces associated with concentration times, including header lines
When Valid: Last designator encountered is used
Character size: 0
Format: Not applicable

53: Measurement Statistics - Measurement Validity Off

Description: Suppresses columns and trailing separated spaces associated with concentration validity, including header lines
When Valid: Last designator encountered is used
Character size: 0
Format: Not applicable

54: Measurement Statistics - STEL Max Off

Description: Suppresses line for STEL max
When Valid: Last designator encountered is used
Character size: 0
Format: Not applicable

55: Measurement Statistics - Maximum Off

Description: Suppresses line for maximum concentration
When Valid: Last designator encountered is used
Character size: 0
Format: Not applicable

56: Measurement Statistics - Minimum Off

Description: Suppresses line for minimum concentration
When Valid: Last designator encountered is used
Character size: 0
Format: Not applicable

57: Measurement Statistics - Average Off

Description: Suppresses line for average concentration
When Valid: Last designator encountered is used
Character size: 0
Format: Not applicable

58 to 99: Reserved

Description: Reserved for future use
When Valid: Never
Character size: Not applicable
Format: Not applicable

Appendix A

Warranty

Seller warrants that the Products will operate or perform substantially in conformance with Seller's published specifications and be free from defects in material and workmanship, when subjected to normal, proper and intended usage by properly trained personnel, for the period of time set forth in the product documentation, published specifications or package inserts. If a period of time is not specified in Seller's product documentation, published specifications or package inserts, the warranty period shall be one (1) year from the date of shipment to Buyer for equipment and ninety (90) days for all other products (the "Warranty Period"). Seller agrees during the Warranty Period, to repair or replace, at Seller's option, defective Products so as to cause the same to operate in substantial conformance with said published specifications; provided that (a) Buyer shall promptly notify Seller in writing upon the discovery of any defect, which notice shall include the product model and serial number (if applicable) and details of the warranty claim; (b) after Seller's review, Seller will provide Buyer with service data and/or a Return Material Authorization ("RMA"), which may include biohazard decontamination procedures and other product-specific handling instructions; and (c) then, if applicable, Buyer may return the defective Products to Seller with all costs prepaid by Buyer. Replacement parts may be new or refurbished, at the election of Seller. All replaced parts shall become the property of Seller. Shipment to Buyer of repaired or replacement Products shall be made in accordance with the Delivery provisions of the Seller's Terms and Conditions of Sale. Consumables, including but not limited to lamps, fuses, batteries, bulbs and other such expendable items, are expressly excluded from the warranty under this warranty.

Notwithstanding the foregoing, Products supplied by Seller that are obtained by Seller from an original manufacturer or third party supplier are not warranted by Seller, but Seller agrees to assign to Buyer any warranty rights in such Product that Seller may have from the original manufacturer or third party supplier, to the extent such assignment is allowed by such original manufacturer or third party supplier.

In no event shall Seller have any obligation to make repairs, replacements or corrections required, in whole or in part, as the result of (i) normal wear and tear, (ii) accident, disaster or event of force majeure, (iii) misuse, fault or negligence of or by Buyer, (iv) use of the Products in a manner for which

they were not designed, (v) causes external to the Products such as, but not limited to, power failure or electrical power surges, (vi) improper storage and handling of the Products or (vii) use of the Products in combination with equipment or software not supplied by Seller. If Seller determines that Products for which Buyer has requested warranty services are not covered by the warranty hereunder, Buyer shall pay or reimburse Seller for all costs of investigating and responding to such request at Seller's then prevailing time and materials rates. If Seller provides repair services or replacement parts that are not covered by the warranty provided in this warranty, Buyer shall pay Seller therefor at Seller's then prevailing time and materials rates. ANY INSTALLATION, MAINTENANCE, REPAIR, SERVICE, RELOCATION OR ALTERATION TO OR OF, OR OTHER TAMPERING WITH, THE PRODUCTS PERFORMED BY ANY PERSON OR ENTITY OTHER THAN SELLER WITHOUT SELLER'S PRIOR WRITTEN APPROVAL, OR ANY USE OF REPLACEMENT PARTS NOT SUPPLIED BY SELLER, SHALL IMMEDIATELY VOID AND CANCEL ALL WARRANTIES WITH RESPECT TO THE AFFECTED PRODUCTS.

THE OBLIGATIONS CREATED BY THIS WARRANTY STATEMENT TO REPAIR OR REPLACE A DEFECTIVE PRODUCT SHALL BE THE SOLE REMEDY OF BUYER IN THE EVENT OF A DEFECTIVE PRODUCT. EXCEPT AS EXPRESSLY PROVIDED IN THIS WARRANTY STATEMENT, SELLER DISCLAIMS ALL OTHER WARRANTIES, WHETHER EXPRESS OR IMPLIED, ORAL OR WRITTEN, WITH RESPECT TO THE PRODUCTS, INCLUDING WITHOUT LIMITATION ALL IMPLIED WARRANTIES OF MERCHANTABILITY OR FITNESS FOR ANY PARTICULAR PURPOSE. SELLER DOES NOT WARRANT THAT THE PRODUCTS ARE ERROR-FREE OR WILL ACCOMPLISH ANY PARTICULAR RESULT.

Appendix B Intrinsic Safety

The SapphIRE analyzer is available in an intrinsically safe model. Intrinsically safe apparatus is apparatus in which any spark or thermal effect, produced either normally or in specified fault conditions, is incapable, under test conditions prescribed in NFPA Standard Number 493 (entitled "Intrinsically Safe Apparatus for use in Division 1 Hazardous Locations 1978"), of causing ignition of a mixture of flammable or combustible material in air in its most easily ignitable concentration. This apparatus is suitable for use in Division 1 locations.

An intrinsically safe unit is restricted with respect to the devices that may be attached when in an area classified as hazardous. Following is a block diagram of what may be attached in hazardous locations. Also listed are several warnings that apply to operation in hazardous areas. To ensure safe operation, please observe these warnings carefully.

I/O CONFIGURATION VS. LOCATION FOR MIRAN SAPPHIRE M205B

Hazardous Locations

Table B-1. Electrical Safety Specifications

Testing Laboratory, Types of Protection, and Area Classification	Application Conditions
ETL and ETL-C Certified, Class I, Division 1, Groups B, C, and D.	Temperature Class T4.

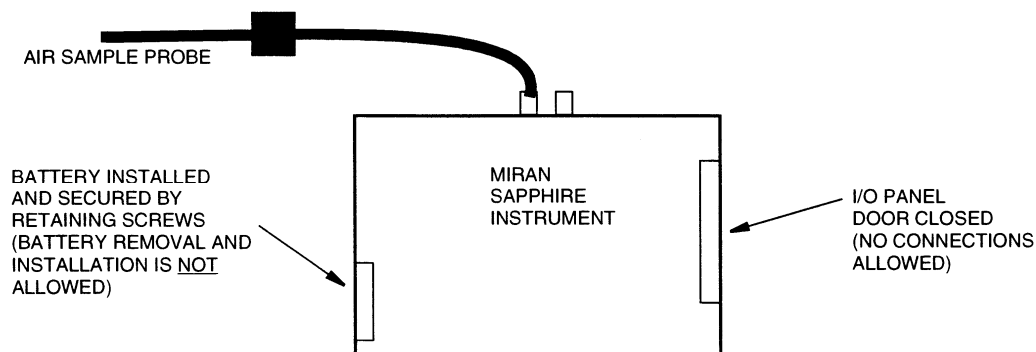

Figure B-1. I/O Configuration in Hazardous Locations

Appendix B Intrinsic Safety

Warning: When operating in hazardous areas:

1. Static discharge hazard. Wipe case with moist cloth before use and avoid rubbing the case against clothing.
2. Do not remove or replace the battery cassette.
3. Keep the I/O panel door closed. No electrical connections are allowed.

In a non-hazardous location, the devices shown in Figure B-2 may be safely attached to the SapphIRE analyzer.

Non-Hazardous Locations

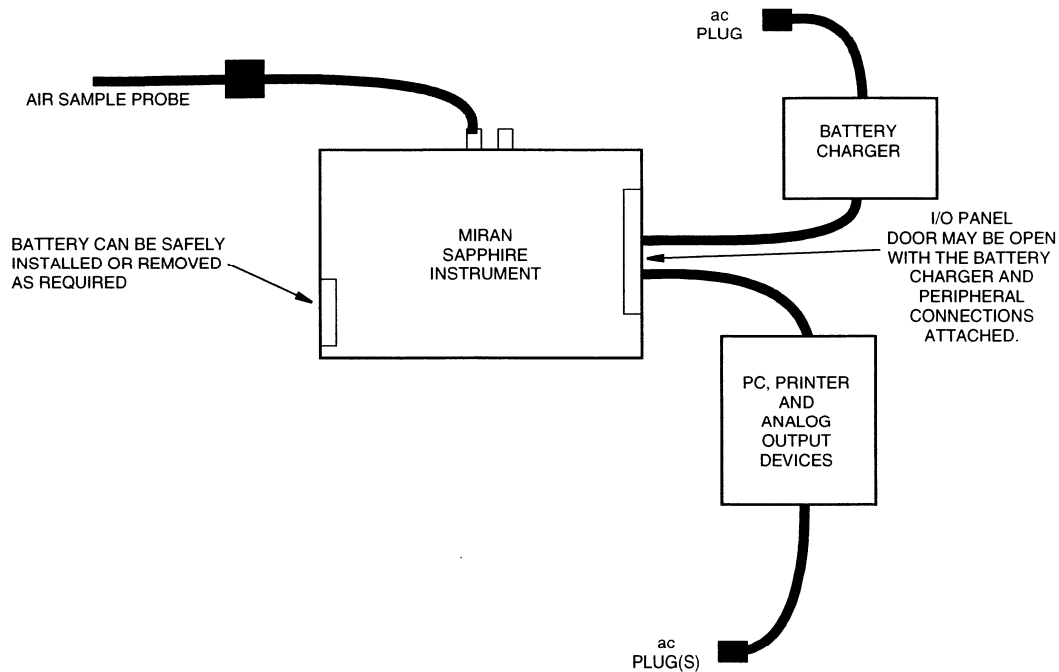

Figure B-2. I/O Configuration in Non-Hazardous Locations

Appendix C

Scan/Calibration Procedure

Note: Creation of custom calibrations should only be attempted by personnel familiar with laboratory procedures, especially the preparation of chemical samples. A working knowledge of infrared spectra is also recommended as the results of the scanning need to be interpreted to yield the best results. Thermo Fisher Scientific strongly suggests that a single gas application and validation for proper performance is attempted before attempting a multi-gas application. Please contact Thermo Fisher Scientific if problems are experienced.

Requirements: The following requirements are necessary before attempting calibration:

- Knowledge of correct procedures for handling chemicals
- Knowledge of Microsoft Excel or other suitable spreadsheet program
- Closed Loop Calibration System
- Suitably sized gas and/or liquid syringe(s)

INTRODUCTION

Before calibrating an application, the analyzing wavelength of the compound of interest must be established. If the wavelength for the compound of interest is known, a scan for the analyzing wavelength is not necessary. However, a more precise analysis is accomplished if the calibration is adjusted for the specific instrument. If the wavelength is unknown, a scan can determine the best analyzing wavelength.

The SapphIRe can do either a peak pick, fast scan, or full scan. A Peak Pick scan should be used when the approximate wavelength of the compound of interest is known. Peak Pick provides a 2.0 micron window (user selectable) of the linear variable filter (LVF) between 8.0 and 14.1 microns to be scanned. All analyzers operating at software version 4.00 or higher possess this feature.

The Fast Scan or Full Scan allows the entire LVF region between 7.7 to 14.1 microns, as well as the seven fixed band pass filters, to be scanned. This is especially valuable when the region of strongest absorbance is unknown. It also may be used to record the spectral characteristics of a gas. The fast scan takes slightly less time while still providing a good spectral representation of the gas. The full scan take slightly longer, but provides higher quality spectral identification through better signal to noise averaging.

Appendix C Scan/Calibration Procedure

The following steps are required to optimize the calibration or to calibrate for an unknown wavelength:

- A. Create a logging site
- B. Perform a peak pick or full-spectrum scan
- C. Download data from the analyzer to a PC
- D. Analyze the spectrum
- E. Create a single- or multi-gas library application
- F. Calibration
- G. Generate a P-Matrix
- H. Enter P-Matrix into analyzer and verify calibration accuracy

A. CREATE A LOGGING SITE

1. From the Main Menu select "3=Site Info"
2. Select "1=New site"
Analyzer displays message, "Warning, starting a site closes the old site data". If an old site does not exist, the instrument skips to step 3.
Select "Enter=Continue"
3. Using the on-screen instructions, input a new site name
Select "Enter=Accept"
4. Select "Escape (ESC)" to return to the Main Menu"
5. From the Main Menu, select "4=Config/Setup"
6. Select "5=Analysis"
7. Select "1=Logging"
8. Select "1=Log mode"
9. Select "2=Single sample"
10. Select "2=Log interval"
The logging interval allows inputting a number and then, by using the down arrow, selecting either seconds, minutes or cycles. For this procedure, input "1"
Press the down arrow (▼=Unit) until the display reads "1 cycles"
Select "Enter=Accept"
11. Select "3=Log Start"
12. Select "1=Manual"
13. Press "Escape (ESC)" three times to return to Main Menu

B. PERFORM A PEAK PICK OR FULL SPECTRUM SCAN

To perform a Peak Pick

- 1 Calculate the injection volume of the compound to be injected into a closed loop system (CLS), using the equations provided in Chapter 12 "User Performance Verification."
- 2 From the Main Menu, select "2=Change gas"
- 3 Select "Enter=Other". (If no application has been selected previously, it skips to Step 4.)
- 4 Select "4=Spectrum scan"
- 5 Select either "5=Full-L" for long path scanning (used for lowest detectable levels) or "6=Full-S" for short path scanning (used for higher concentration scans). Note that higher quality results are obtained using a full scan. The Main Menu returns.
- 6 From the Main Menu select "1=Analyze/Start"
- 7 If the Peak pick range is correct, input "Enter=Continue", skip to step 11
- 8 Select "1=Change"
- 9 Input beginning wavelength and select "Enter"
- 10 Input ending wavelength and select "Enter" (must be 2.0 microns or less)
- 11 Select "1=New zero". This step is omitted if no zero was saved from a previous analysis, and the instrument skips to step 12.
- 12 Attach the closed loop system to the analyzer ("in" port on pump attaches to "out" port on analyzer, "out" port on pump attaches to "in" port on analyzer). Note that the instruction to "Install chemical filter" does not apply to a spectrum scan, and the closed loop system should be installed.
- 13 Turn closed loop system pump ON for approximately 15 seconds. Select "Enter=Continue" and wait for zero scan (approximately 1 minute)
- 14 If "Zero Save" is on automatic (see Analysis Preferences screen), there is no option either to repeat zero or save zero. If "Zero Save" is not on automatic, there will be a prompt to select "1=Repeat Zero" or "Enter=Save". After the zero is saved, the prompt is to install the particulate filter. Do not do this. Instead make an injection and press "Enter=Continue."

Appendix C Scan/Calibration Procedure

- 15 Use a suitably sized syringe to introduce the compound to be scanned into the injection port of the closed loop system.¹ The injection volume was calculated in step 1. Turn pump ON for approximately 30 seconds. Press "Enter=Continue".

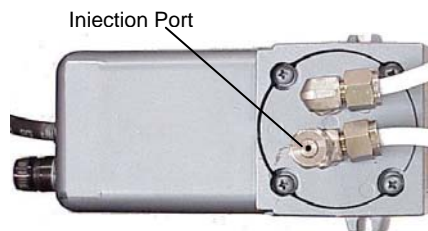

- 16 The analysis menu on the right displays an option for "1=Start Logging". Select this option. After a short period where the pump circulates the compound, the analyzer displays "Log in progress" after the countdown.
- 17 At the end of the Peak pick, select "Enter=Save".
- 18 Press "Esc" until Main menu appears.
- 19 Use pump to remove compound from analyzer (approximately 5 minutes).

To perform a Full Spectrum Scan

1. Calculate the injection volume of the injected compound into a Closed Loop System (CLS) using the equations provided in Chapter 12 "User Performance Verification."
3. From the Main Menu, select "2=Change gas"
4. Select "Enter=Other". (If no application has been selected previously, it skips to Step 3.)
5. Select "4=Spectrum scan"
6. Select either "5=Full-L" for long path scanning (used for lowest detectable levels) or "6=Full-S" for short path scanning (used for higher concentration scans). Note that higher quality results are obtained using a full scan. The Main Menu returns.
7. From the Main Menu select "1=Analyze/Start"
8. Attach the closed loop system to the analyzer ("in" port on pump attaches to "out" port on analyzer, "out" port on pump attaches to "in" port on analyzer). Note that the instruction to "Install chemical filter" does not apply to a spectrum scan, and the closed loop system should be installed.
9. Turn closed loop system pump ON for approximately 15 seconds. Select "Enter=Continue" and wait for zero scan (approximately 5 minutes)

¹ A gas or liquid syringe is required, depending upon the compound. Many compounds (e.g., benzene) are more expensive and only available in larger quantities in gaseous form, and are therefore usually inserted into the pump as a liquid. The pump evaporates the liquid before it is introduced to the analyzer. Syringes can be obtained from chemical or scientific supply houses.

10. If "Zero Save" is on automatic (see Analysis Preferences screen), there is no option either to repeat zero or save zero. If "Zero Save" is not on automatic, there will be a prompt to select "1=Repeat Zero" or "Enter=Save". After the zero is saved, the prompt is to install the particulate filter. Do not do this. Instead make an injection and press "Enter=Continue."
11. Use a suitably sized syringe to introduce the compound to be scanned into the injection port of the closed loop system². The injection volume was calculated in step 1. Turn pump ON for approximately 30 seconds. Press "Enter=Continue".
12. The analysis menu on the right displays an option for "1=Start Logging". Select this option. After a short period where the pump circulates the compound, the analyzer displays "Log in progress" after the countdown.
13. At the end of the full spectrum scan, select "Enter=Save".
14. Press "Esc" until Main menu appears.
15. Use pump to remove compound from analyzer (approximately 5 minutes).

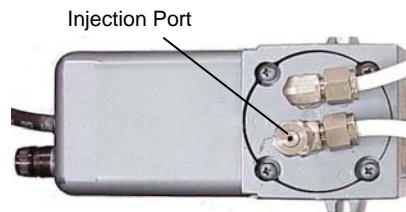

C. DOWNLOAD DATA FROM THE ANALYZER TO A PC

1. Connect 9-pin cable from SapphIRE's serial output to PC's serial port.
2. On the PC open the ThermoConnect program.
3. From the SapphIRE's Main Menu select "5=Report/Data".
4. Choose "1=Select site" and select the site with the logged data.
5. Select "3=Data transfer".
6. Select "3=Send/receive".
7. On PC choose "F2=File".
8. Highlight a file to receive the logged data. To create a new file, type in the name of the file (8 character maximum). It is suggested that the extension ".txt" be used (i.e., testfile.txt) to allow ease of importing into other applications. If a new file was created, press "Enter" on the PC keyboard.
9. On the PC choose "F5=Receive".
10. On the PC choose "F5=Site".
11. If the file selected in Step 8 exists, it will be overwritten by pressing "Y".
12. When the operation is complete, the PC screen displays "Transfer Complete". Press any key.
13. On the instrument, press "ESC" to return to the Main Menu

² A gas or liquid syringe is required, depending upon the compound. Many compounds (e.g., benzene) are more expensive and only available in larger quantities in gaseous form, and are therefore usually inserted into the pump as a liquid. The pump evaporates the liquid before it is introduced to the analyzer. Syringes can be obtained from chemical or scientific supply houses.

D. ANALYZE THE SPECTRUM

1. In PCIP, highlight the file containing the logged scan data and press "F2=Edit". The file should contain a header and two columns. The first column contains the wavelength data and the second column is the corresponding absorbance.
2. The wavelength typically chosen corresponds to the maximum absorbance in the scanned range. Record this wavelength.
3. At this point data may be imported into a program capable of graphing the data (e.g., ThermoMatch, Excel, Lotus, MatLab). This will visually represent the raw spectra and aid in the selection of the best spectral peak.

E. CREATE A NEW SINGLE GAS OR MULTI-GAS LIBRARY APPLICATION

In many cases, more than one gas exists in an atmosphere. It may be necessary to measure these gases simultaneously. One reason for this is that several spectra may overlap at the analyzing wavelengths, resulting in interference that requires compensation. Another reason for simultaneous measurement is to expedite the measurement process.

In order to determine whether interference exists it is necessary to compare the infrared spectra of the gases. Spectra may be obtained from internet web sites such as the NIST Chemistry Webbook (<http://webbook.nist.gov/chemistry/>). It will be necessary to print out the appropriate spectra and overlay them to determine if interference exists. Reference books such as Brian Thompson's "Hazardous Gases and Vapors: Infrared Spectra and Physical Constants", Beckman Instruments, Inc. Industrial Technical Report TR-595, 1974 can also be used. Alternately, the SapphIRe can be used to generate spectra of known gases.

The following procedure is used to create a library application once it has been determined whether a single or multi-gas application is appropriate.

<p>Note: Many of the steps used to create a single or multi-gas library are identical. They are clearly identified where they differ.</p>
--

1. From the Main Menu select "2=Change gas".
2. From Select Applic menu select "Enter=Other". If no application has been previously selected, this step is omitted and the instrument skips to step 3.
3. From Applic menu select "2=Single gas" or "3=Multi-gas"
4. Choose the first empty position number (e.g., "2=<empty 2>"). The analyzer will beep and an error message will state that an application processing error has occurred and the application is invalid. Ignore this message and select "Enter=Continue".

5. The main menu reappears. From it, select "4=Config/Setup"
6. Select "5=Analysis"
7. Press the UP (▲) arrow key
8. Select "3=Application view and edit".
9. The "Application type" screen should indicate "Single gas" or "Multi-gas", depending upon which was selected in step 3. Press "▼=Next".
10. The "Application primary name" should indicate "????????". Select "1=Change".
11. Follow the on-screen instructions to enter a primary name (e.g., CO₂)
12. The Application secondary name can be left blank. Select "▼=Next".
13. The Application gas count should be 1 if the application is for a single gas. If it is a multi-gas application, change the number to the amount of gases being monitored. Select "▼=Next".
14. The Application group TWA mode default is Off. Select "▼=Next".
15. In the Gas summary select "1=Change".
16. Select "1=Change" in the Application gas name screen. Follow the on-screen instructions to enter a name to be displayed during the application analysis (e.g., CO₂). After entering a name select "Enter=Accept".
17. The Application gas unit default is ppm. Press "▼=Next".
18. The Application gas HRL is a set value that tells the instrument what concentration range the application is calibrated for. Select "1=Change" to set the upper calibrated range (this value MUST be entered!). When the upper concentration value is entered, select "Enter=Accept"
19. This screen allows choosing the number of digits to the right of the decimal point that will be displayed during the application analysis. The Application gas decimal point max default is 0. The maximum number is 2. Press "▼=Next" to accept the default value or "1=Change" (typically higher upper concentration values require fewer digits to the right of the decimal point).
20. The Application gas high alarm default is "---- ppm". Select "1=Change" to set a value. Typically, the gas high alarm is the same value as the HRL. Enter a value and select "Enter=Accept".
21. The Application gas low alarm default is "---- ppm". Select "1=Change" to set a value, or "▼=Next". Enter a value and select "Enter=Accept".
22. The Application gas STEL alarm default is "---- ppm". Select "1=Change" to set a value, or "▼=Next". Enter a value and select "Enter=Accept".
23. The Application gas STEL time default is "Off". Select "1=Change" to set a value, or "▼=Next". Enter a value and select "Enter=Accept".
24. The Application gas molecular weight default is "Off". Select "1=Change" to set a value, or "▼=Next" (this value MUST be entered if the gas units are mg/m³).

Appendix C Scan/Calibration Procedure

25. The Application gas liquid density default is "Off". Select "1=Change" to set a value , or "▼=Next".
26. For Multi Gas Library Application Only: The Application gas GTWA weight default is "Off". Select "1=Change" to set a value , or "▼=Next".
27. For Multi Gas Library Application Only: The instrument returns to the Gas Summary screen for the second gas. Repeat steps 15-26 for each gas.
28. For Single Gas Library Application Only: The Application wave count default is 1. Select "▼=Next".
For Multi Gas Library Application Only: Enter the number of wavelengths to be analyzed.
29. The Wavelength Summary screen shows the wavelength that the analyzer will measure at. Select "1=Change".
30. Again select "1=Change".
31. Enter the wavelength recorded in step D-2, and select "Enter=Accept" (this value MUST be entered!).
32. The Wavelength H₂O absorbance should be left at the default value to disable humidity compensation. Select "▼=Next".
33. For Multi Gas Library Application Only: The instrument returns to the Wavelength Summary screen for the second wavelength. Repeat steps 29-32 for each wavelength.
34. The Application temperature compensation reference default value is "Off". Select "▼=Next".

Note: To support temperature compensation, set this value to reference temperature instead.

35. The Application pressure compensation reference default value is "Off". Select "▼=Next".

Note: To support pressure compensation, set this value to reference pressure instead.

36. The Reference Compensation default is "Off". If the application requires a reference wavelength, (4.004 is recommended), select "1=Change", "1=Change", "2=Enabled" and "1=Change". Enter the reference wavelength and "1=Change" to edit the application measurement drift (typically 2.0%). "▼=Next" (see "Reference Compensation" in Chapter 7 for an explanation of this function). Select "Enter=Accept".
37. The Humidity compensation default is "Off". Select "▼=Next". Contact Thermo Fisher Scientific before enabling humidity compensation for humidity compensation coefficients.

38. The Application pathlength can be set for "Long" or "Short". Press "1=Change" to select the appropriate pathlength and then "▼=Next". For optimum sensitivity the long pathlength should be used. The short pathlength is recommended for very high concentration measurements.
39. The Application dwell time default is "275". Select "▼=Next".
40. The Application purge % of max default is "100%". Select "▼=Next".
41. The Application batch mode default is "Enabled". Select "▼=Next".
42. The Application batch purge % default is "100%". Select "▼=Next".
43. For Single Gas Library Application: From the Meas Absorb → Conc screen, enter the measurement absorbance concentration. These values MUST BE ENTERED. Select each parameter and "1=Change".
For Multi Gas Library Application: From the "Matrix Parameters" screen, select "1=Change".
44. For Single Gas Library Application Only: In the PQ Cal Range screen, select "1=Range".
45. For Both Single and Multi-gas Library Application: Select "1=Q" and, since the quadratic term is unknown at this point because the P-matrix has not been generated yet, enter "0" and then "Enter=Accept".
46. For Both Single and Multi-gas Library Application: Select "2=P" and, since the linear term is unknown at this point because the P-matrix has not been generated yet, enter "1" and then "Enter=Accept". Note that for multi gas library applications, steps 43 and 44 must be repeated for each gas at each wavelength.
47. For Single Gas Library Application: From the "PQ cal params" screen, select "4=Absorb range" and enter "1.2". Select "Enter=Accept".
48. For Both Single and Multi-gas Library Application: Press "ESC" until analyzer asks to save changes. Select "Enter=Save".
49. For Both Single and Multi-gas Library Application: Press "ESC" 2 times to return to the main menu. At this point the application is valid for use.

F. CALIBRATION

1. Calculate five injection volumes that cover the complete concentration range (also see Chapter 12). E.g., if the concentration is 0 to 1000 ppm, the concentrations should be approximately 200, 400, 600, 800, and 1000 ppm.

For liquid injection volumes³, use the formula: $VI = (C) \left(\frac{V_T}{10^3} \right) \left(\frac{P}{R} \right) \left(\frac{M}{d} \right)$

For gas injection volumes³, use the formula: $VI = (C) (V_T)$.

Where:

VI = injection volume in microliters (μL)

C = concentration volume in parts per million (ppm)

V_T = total volume of cell and calibration system in liters (2.24L)

d = Liquid density (g/cm^3)

M = Molecular weight of sample

$\frac{P}{R}$ = Molar volume of gas $\left(\frac{1}{24.4} \text{ at } 25^\circ\text{C} \right)$

Note: In the above example, 200 (the lowest concentration) x 2.24 (the cell volume) = an injection volume of 448 μL . Since most syringes are not precise enough to measure an injection volume of 448 μL , select an injection volume that can be accurately measured by the syringe. In the above example it will be 450 μL . Transpose the formula to $C = V_i/V_T$, and solve for the concentration (C). In this example, $C = 450/2.24 = 200.1$. Record both the concentrations and injection volumes.

2. From the Main Menu select "1=Analyze/Start"
3. Select "1=New Zero"
4. At the prompt "Install chemical filter", attach the Closed Loop Calibration System and turn the pump on. Select "Enter=Continue"
5. Allow instrument to purge with "Zero Air" or clean air.. The instrument will purge for 1 minute then proceed to set the Zero.
6. At the prompt for "Install Particulate filter", keep the Closed Loop Calibration System attached. Press "Enter=Continue" and allow the instrument to purge the Zero Air sample. When the purge is complete, select \blacktriangle or \blacktriangledown until the Absorbance screen appears. Verify that the absorbance equals zero(+/- .0010).

³ Depending upon the compound, either a gas or liquid may be injected,. Many compounds (e.g., benzene) are not readily available in gaseous form, and are therefore inserted into the pump as a liquid. The pump evaporates the liquid before it is introduced to the analyzer.

7. For Single Gas Library Application: Inject first volume and wait for absorbance to stabilize. Record absorbance value. Air out the instrument and repeat until the absorbance returns to zero (± 0.0010 AU). Reconnect the pump and repeat for each injection volume. Rezero the instrument if the absorbance is outside of the allowable ± 0.0010 AU.

For Multi Gas Library Application: Inject first volume and select "Enter=new sample". Wait for absorbance reading to appear. Record absorbance value at all wavelengths, and repeat for all concentrations and compounds. Flush the system until absorbance returns to zero by disconnecting the pump and exhausting the system (e.g., by attaching an exhaust line to the out port of the instrument). Attach the closed loop pump and select "2=Zero". Repeat steps 3-7.

Note: Depending upon the compound it may not be necessary to flush the system after each injection. For example, if the absorbance value stabilizes, introduce the difference between injection values. This will save time. If, however, the absorbance value continues to fall, it will be necessary to flush the system, and introduce the new injection volume value (e.g., by attaching an exhaust line to the out port on the instrument).

G. GENERATE THE P-MATRIX

Note: The following assumes Microsoft Excel is used to generate the P-Matrix. The procedure may differ if other programs or instruments, such as a calculator, are used.

1. For Single Gas Library Application: Enter absorbancies from the individual compound injections made during the calibration in one column starting at cell B2. Absorbancies should be entered to four decimal places.
For Multi Gas Library Application: Enter absorbancies starting at cell B2. Enter absorbancies for each wavelength in adjacent columns. Absorbancies should be entered to four decimal places. Enter the next compound directly below the first compound (see example, below).

	Wavelength	
	1	2
Compound 1	0.0058	0
	0.0128	0
	0.0217	1
Compound 2	0.0001	100
	0.0002	214
	0.0002	355

Appendix C Scan/Calibration Procedure

2. For Single Gas Library Application: Click first cell adjacent to the absorbance matrix (C2 if application is single gas) and type " $=B2^2$ " (without the quotation marks), and press the Enter key. Return the mouse to the lower corner of cell C2 (if single gas application) until the mouse character turns into a "+". Press the left mouse button and drag the cell to the same length as the absorbance matrix. Label this the "A" matrix in the column to the left.
For Multi Gas Library Application: Click first cell adjacent to the upper right-hand cell of the absorbance matrix and type " $=B2^2$ " (without the quotation marks), and press the Enter key. Return the mouse to the cell with the equation and drag the column to the right to match the width of absorbance matrix, then drag this row down to match the length of the absorbance matrix. The absorbance matrix should be adjacent to the absorbance squared matrix. Label this the A matrix in the column to the left.
3. For Single Gas Library Application: Skip one column and enter the corresponding concentration values in PPB units. The PPB units are the injected concentration values that resulted in each absorbance row in the A matrix. The resulting area should have the same number of rows and half the number of columns as the A matrix. Label this the C matrix in an adjacent column.
For Multi Gas Library Application: Skip one column and enter the corresponding concentration values in PPB units. The PPB units are the injected concentration values that resulted in each absorbance row in the A matrix. The rows should be entered by grouped compound injections and the columns should display the compound concentration in the order that the compounds are read on the instrument display. The resulting area should have the same number of rows and half the number of columns as the A matrix. Label this the C matrix in an adjacent column.
4. Highlight the A matrix and click Edit/Copy. Skip one row from the matrix and click the cell. Click Edit/Paste Special, check the transpose box, then click "OK". Label this the A' matrix.
5. Skip one row and highlight an area with the same number of columns as the A matrix and the same number of rows as the A' matrix. Type " $=MMULT($ ". With the mouse, highlight the A' matrix and type ",". With the mouse highlight the A matrix and type ")". Simultaneously press Control, Shift and Enter. Label this the A'A matrix.
6. Skip one row and highlight an area having the same number of columns and rows as the (A'A) matrix. Type " $=MINVERSE($ ". With the mouse highlight the (A'A) matrix, and type ")". Simultaneously press Control, Shift and Enter. Label this the INV(A'A) matrix.
7. Skip one row and highlight an area having the same number of columns as the A' matrix and the same number of rows as the INV(A'A) matrix. Type " $=MMULT($ ". With the mouse highlight the INV(A'A) matrix and type ",". With the mouse highlight the A' matrix and type ")". Simultaneously press Control, Shift and Enter. Label this the INV(A'A)*A' matrix.

8. Skip one row and highlight an area having the same number of columns as the C matrix and the same number of rows as the $INV(A'A)*A'$ matrix. Type " $=MMULT($ ". With the mouse highlight the $INV(A'A)*A'$ matrix and type " $,$ ". With the mouse highlight the C matrix and type " $)$ ". Simultaneously press Control, Shift and Enter. Label this the P matrix.
9. For Single Gas Library Application: The first number is the P term and the second number is the Q term
For Multi Gas Library Application: Each column of the P matrix contains the P (linear) and Q (quadratic) terms for each compound. The first half of the numbers in each column are the P terms and the second half are their associated Q terms (see table, below).

H. ENTER P-MATRIX INTO THE ANALYZER AND VERIFY CALIBRATION ACCURACY

1. The P matrix for a single compound application consists of two numbers; the 'P', linear term and the 'Q' Quadratic term.
2. From the Main Menu, select "4=Config/Setup "
3. Select "5= Analysis"
4. Press "▲ =More"
5. Select "3=Applic View and edit"
6. If entering a P Matrix for a multi compound application, go to step 14.
7. For Single Gas Library Application: Press "▲ =Prev" to view the "Meas Absorb --> Conc" screen
8. For Single Gas Library Application: In the "Meas Absorb --> Conc" screen, select "1=change", and "1=Range 1".
9. For Single Gas Library Application: Select "1=Q" and enter the Q term. Select "Enter" to accept.
10. For Single Gas Library Application: Select "2=P" and enter the P term. Select "Enter" to accept.
11. For Single Gas Library Application: The "R" term is left at Zero.
12. For Single Gas Library Application: Select "4=Absorb range" and enter the absorbance value x 1.2 of the maximum concentration of application.
13. For Single Gas Library Application: If entering a P Matrix for a single compound application, go to step 19.
14. For Multi Gas Library Application: A multi compound P-matrix consists of one column for each compound. The upper half of the rows are the 'P', linear terms for each wavelength, and the lower half are the corresponding 'Q', quadratic terms for each wavelength (see example, below).

Appendix C Scan/Calibration Procedure

	Gas 1	Gas 2	Gas 3
Wave 1	P 11	P 21	P 31
Wave 2	P 12	P 22	P 32
Wave 3	P 13	P 23	P 33
Wave 1	Q 11	Q 21	Q 31
Wave 2	Q 12	Q 22	Q 32
Wave 3	Q 13	Q 23	Q 33

15. For Multi Gas Library Application: Press "**▲**=Prev" to get to the Matrix Parameters screen. From the Matrix Parameters screen enter the P and Q values. To enter the Q value for the first compound at the first wavelength, select "1=Change", and "1=Q" Enter the Q value and select "Enter=Accept". To enter the P value for the first compound at the first wavelength, select "1=Change", and "2=P" Enter the P value and select "Enter=Accept".
16. For Multi Gas Library Application: Press "**▼**=Next" to enter the Q value for the first compound at the second wavelength. Select "1=Change", and "1=Q" Enter the Q value and select "Enter=Accept". To enter the P value for the first compound at the second wavelength, select "1=Change", and "2=P" Enter the P value and select "Enter=Accept".
17. For Multi Gas Library Application: Continue with the procedures described in steps 15 and 16 until the P and Q terms have been entered for all compounds at all wavelengths.
18. For Both Single and Multi Gas Library Applications: For both single and multigas library applications, press "ESC" until the analyzer prompts to save the changes made. If the changes are correct, select "Enter=Save".
19. For Both Single and Multi Gas Library Applications: Press "ESC" until the Main Menu appears. The specific SapphIRe instrument is now calibrated for the compound(s) of interest.
20. For Both Single and Multi Gas Library Applications: Verify the calibration by entering known concentrations of the target compound. To do this, insert an injection volume that is in the middle of the concentration range and verify that the concentration reading is within $\pm 10\%$ of the reading obtained during calibration.

Appendix D

HUMIDITY COMPENSATION TABLE

Wavelength	P
3.333	0.1421
3.573	0.0000
4.004	0.0000
4.250	0.0000
4.500	0.0076
4.620	0.0173
7.700	0.3414
7.725	0.3754
7.750	0.4182
7.775	0.4014
7.800	0.3674
7.825	0.3320
7.850	0.2976
7.875	0.2685
7.900	0.2467
7.925	0.2311
7.950	0.2222
7.975	0.2192
8.000	0.2184
8.025	0.2172
8.050	0.2123
8.075	0.2011
8.100	0.1830
8.125	0.1641
8.150	0.1427
8.175	0.1229
8.200	0.1044
8.225	0.0900
8.250	0.0818
8.275	0.0775
8.300	0.0760
8.325	0.0759
8.350	0.0753
8.375	0.0744
8.400	0.0730
8.425	0.0718
8.450	0.0699
8.475	0.0681
8.500	0.0674
8.525	0.0672
8.550	0.0677
8.575	0.0690
8.600	0.0702
8.625	0.0711
8.650	0.0710
8.675	0.0697
8.700	0.0665

Wavelength	P
8.725	0.0625
8.750	0.0576
8.775	0.0527
8.800	0.0484
8.825	0.0441
8.850	0.0410
8.875	0.0383
8.900	0.0364
8.925	0.0345
8.950	0.0333
8.975	0.0317
9.000	0.0302
9.025	0.0299
9.050	0.0297
9.075	0.0298
9.100	0.0309
9.125	0.0330
9.150	0.0351
9.175	0.0381
9.200	0.0403
9.225	0.0423
9.250	0.0441
9.275	0.0450
9.300	0.0459
9.325	0.0464
9.350	0.0465
9.375	0.0454
9.400	0.0449
9.425	0.0430
9.450	0.0408
9.475	0.0378
9.500	0.0347
9.525	0.0315
9.550	0.0283
9.575	0.0249
9.600	0.0220
9.625	0.0190
9.650	0.0174
9.675	0.0156
9.700	0.0144
9.725	0.0136
9.750	0.0000
9.775	0.0000
9.800	0.0000
9.825	0.0000
9.850	0.0000
9.875	0.0000

Wavelength	P
9.900	0.0000
9.925	0.0135
9.950	0.0138
9.975	0.0137
10.000	0.0138
10.025	0.0138
10.050	0.0132
10.075	0.0131
10.100	0.0131
10.125	0.0126
10.150	0.0121
10.175	0.0122
10.200	0.0123
10.225	0.0125
10.250	0.0129
10.275	0.0131
10.300	0.0137
10.325	0.0143
10.350	0.0147
10.375	0.0157
10.400	0.0160
10.425	0.0168
10.450	0.0174
10.475	0.0188
10.500	0.0194
10.525	0.0205
10.550	0.0215
10.575	0.0221
10.600	0.0232
10.625	0.0241
10.650	0.0255
10.675	0.0257
10.700	0.0266
10.725	0.0276
10.750	0.0284
10.775	0.0298
10.800	0.0306
10.825	0.0315
10.850	0.0323
10.875	0.0333
10.900	0.0339
10.925	0.0346
10.950	0.0344
10.975	0.0341
11.000	0.0343
11.025	0.0340
11.050	0.0332

Appendix D Humidity Compensation Table

Wavelength	P
11.075	0.0324
11.100	0.0317
11.125	0.0307
11.150	0.0298
11.175	0.0287
11.200	0.0281
11.225	0.0274
11.250	0.0268
11.275	0.0262
11.300	0.0258
11.325	0.0256
11.350	0.0258
11.375	0.0257
11.400	0.0259
11.425	0.0259
11.450	0.0254
11.475	0.0249
11.500	0.0250
11.525	0.0253
11.550	0.0253
11.575	0.0256
11.600	0.0265
11.625	0.0274
11.650	0.0289
11.675	0.0300
11.700	0.0312
11.725	0.0322
11.750	0.0331
11.775	0.0329
11.800	0.0342
11.825	0.0337
11.850	0.0334
11.875	0.0324
11.900	0.0319
11.925	0.0305
11.950	0.0293
11.975	0.0288
12.000	0.0274
12.025	0.0268
12.050	0.0269
12.075	0.0272
12.100	0.0268

Wavelength	P
12.125	0.0271
12.150	0.0272
12.175	0.0279
12.200	0.0285
12.225	0.0296
12.250	0.0304
12.275	0.0321
12.300	0.0333
12.325	0.0353
12.350	0.0385
12.375	0.0419
12.400	0.0462
12.425	0.0513
12.450	0.0562
12.475	0.0599
12.500	0.0647
12.525	0.0687
12.550	0.0702
12.575	0.0721
12.600	0.0729
12.625	0.0723
12.650	0.0703
12.675	0.0688
12.700	0.0667
12.725	0.0640
12.750	0.0616
12.775	0.0584
12.800	0.0573
12.825	0.0572
12.850	0.0568
12.875	0.0558
12.900	0.0558
12.925	0.0552
12.950	0.0545
12.975	0.0528
13.000	0.0519
13.025	0.0498
13.050	0.0488
13.075	0.0476
13.100	0.0471
13.125	0.0468
13.150	0.0493

Wavelength	P
13.175	0.0517
13.200	0.0532
13.225	0.0569
13.250	0.0598
13.275	0.0645
13.300	0.0701
13.325	0.0735
13.350	0.0802
13.375	0.0839
13.400	0.0896
13.425	0.0930
13.450	0.0944
13.475	0.0963
13.500	0.0973
13.525	0.0963
13.550	0.0959
13.575	0.0972
13.600	0.0894
13.625	0.0884
13.650	0.0834
13.675	0.0815
13.700	0.0776
13.725	0.0748
13.750	0.0711
13.775	0.0691
13.800	0.0672
13.825	0.0651
13.850	0.0654
13.875	0.0646
13.900	0.0645
13.925	0.0654
13.950	0.0666
13.975	0.0691
14.000	0.0718
14.025	0.0779
14.050	0.0847
14.075	0.0924
14.100	0.1012

Appendix E

MIRAN[®] SapphIRe Field Performance Verification Kit

The SapphIRe Field Performance Verification Kit (Kit Part Number: CR014LG) includes the following items:

Quantity	Part No.	Item
1	CR014MA	Gas Delivery System
1	CR014LN	Cylinder of N ₂ O and SF ₆ mixture in air
1	NA	Material Safety Data Sheets (N ₂ O and SF ₆)
1	MI 611-035	Instruction Manual

Replacement parts for this kit must be ordered directly from Thermo Fisher Scientific. To order parts, call: 1-508-520-0430

GENERAL

This kit contains the necessary parts and instructions to verify the performance of the MIRAN SapphIRe Analyzer. The stated accuracies of the gas concentrations are not valid beyond the expiration date appearing on the gas tank label. The gas concentrations have been deliberately chosen to permit safe operation; the levels are at or below the corresponding action levels and are further diluted immediately upon release to the atmosphere.

INTRODUCTION

The field performance check kit consists of a gas mixture containing nitrous oxide, sulfur hexafluoride and balance zero air. The nominal concentrations and their tolerances are:

Nitrous Oxide (N₂ O): 25 parts per million (ppm), ± 0.5 ppm.
Sulfur Hexafluoride (SF₆): 1.0 parts per million (ppm), ± 0.02 ppm.

The mixture is contained within a small gas cylinder of approximately 1 liter in volume at a total pressure of approximately 150 psig (compresses 11 liters of gas at atmospheric conditions to 1 liter at 150 psig). At this pressure there is sufficient gas to perform at least one complete calibration check.

Caution: Observe the caution printed on the tank label concerning storage temperature (maximum = 130°F). Always orient the tank discharge point away from the face and body. Wear safety goggles or safety glasses when using this accessory.

MIRAN Sapphire Field Performance Verification Kit

The steps involved in kit use are discussed in the sections that follow. The three steps are:

1. Configure the analyzer for "Performance Verification".
2. Configure the gas cylinder with the sample delivery system.
3. Run the challenge gas.

INSTRUMENT CONFIGURATION

Each instrument is configured with the "Performance verification application" titled "CALCHECK". From the Main Menu, select 4 = Config/Setup. From the Setup Menu, select 1 = Calibration. From the Calibration Menu, select 3 = Performance Verification. The left side of the screen changes to show N2O and SF6.

If the ambient pressure differs significantly and log the actual response data is to be logged, select a logging interval of one cycle. This sets up the application to produce the most rapid updating of displayed concentrations. If the normal logging configuration for this application is changed, remember to reconfigure the instrument to the original parameters following this test.

It is assumed that the instrument has already been powered and warmed up for a period of at least 30 minutes.

CONFIGURING THE GAS SAMPLING ACCESSORY

The gas sampling accessory consists of a coiled length of tubing and associated hardware (Figure E-1). One end is terminated with a tubing sleeve designed to fit snugly over the INLET port of the analyzer. A small piece of capillary tubing, which is inserted into the gas tank (trigger) nozzle, is found at the other end. This assembly should always be inspected before use to make sure there are no obvious loose connections, punctured tubing, or debris that may have found its way into the tubing sleeve.

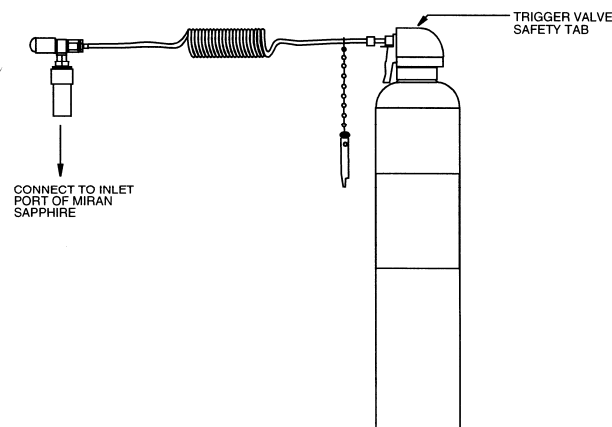

Figure E-1. Gas Sampling Accessory (shown assembled to gas tank)

Warning: The gas tank is shipped with a trigger valve safety tab. DO NOT REMOVE THIS TAB UNTIL AFTER THE GAS SAMPLING LINE HAS BEEN FULLY INSTALLED.

Grasp the capillary tubing end of the sampling line at the location indicated in Figure E-2, and slowly push it into the nozzle opening on the gas tank. When the tubing is fully inserted, only about 1/8 inch of the capillary remains exposed. Use the other hand to hold the gas tank valve mechanism proper.

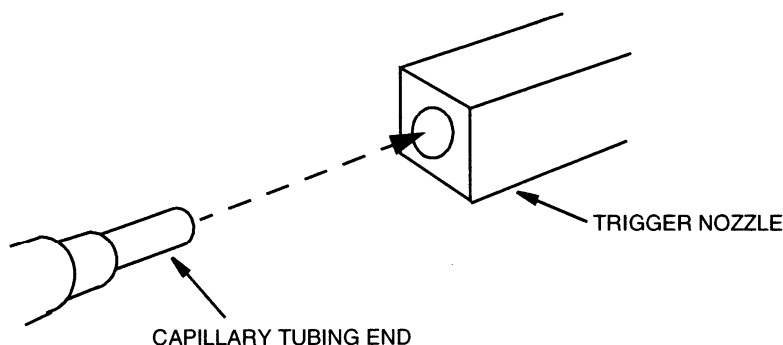

Figure E-2. Inserting the Capillary into the Gas Tank

GAS CHALLENGE

Zero Analyzer

The next step is to zero the analyzer as directed by the menu prompts. Once the analyzer is zeroed, the displayed concentrations for both gases should be substantially zero; if the data is to be logged, select the option from the displayed menu.

At this point, do not remove the zero filter. Instead, perform several more complete measurement cycles to confirm a stable zero. Typically, another minute of operation in this condition is sufficient.

Attaching the Sampling Accessory

After several measurement cycles have elapsed, turn off the pump by pressing the CONTROL key and selecting 2=PUMP OFF.

Note: The pump must be off during delivery of the calibration gas.

With the pump off, proceed as follows:

1. Attach the tubing sleeve to the INLET port of the analyzer.
2. Remove the trigger valve safety tab from the gas tank delivery nozzle.

3. Slowly squeeze the trigger. When the trigger is fully depressed, insert the trigger holder as shown in Figure E-3. This holder keeps the gas tank valve open while the test proceeds. Once the gas sampling accessory is installed, lay the complete assembly down with no further intervention. Watch the gas readings climb.

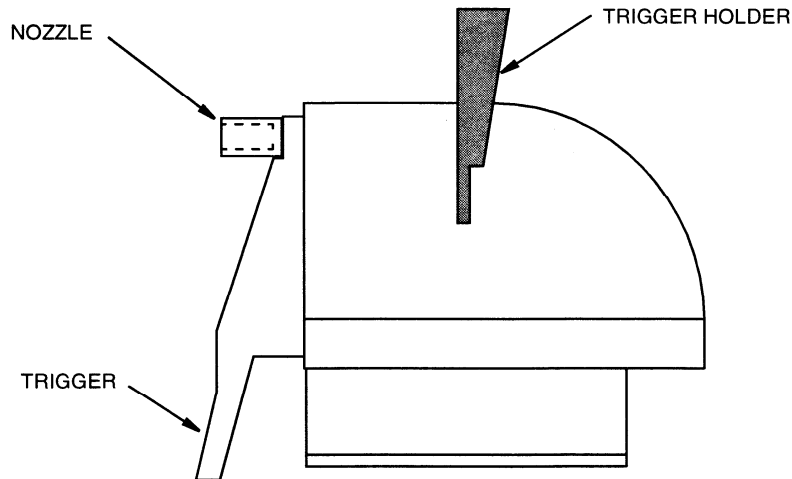

Figure E-3. Inserting the Trigger Holder

Caution: If, during this operation, the small capillary tubing is ejected from the nozzle, remove the trigger holder to shut off gas flow. Then reinsert the tubing, making sure to slide the tubing in far enough. It should remain in place even if slight rearward tugs are applied to it. Always firmly grasp a portion of the capillary tubing as it is removed.

4. The displayed gas readings should first rise and then, after approximately 3-4 minutes, level off and stabilize. Note these readings.

Disconnecting the Sampling Accessory

After the readings have stabilized and have been recorded:

1. Remove the trigger holder from the gas tank. This normally shuts off the flow of any gas remaining in the tank, but a slight upward nudge on the trigger itself ensures that the tank valve is fully closed.
2. Remove the tubing sleeve from the INLET port and reattach the zero filter.
3. Restart the pump by selecting Option 2 from the CONTROL menu; the concentration readings should now begin to drop. Continue until the readings have returned to substantially zero. At this point, the analysis may be terminated to stop logging. Remember to upload the file for subsequent analysis.
4. Remove the capillary tubing end from the tank trigger nozzle and return the sampling accessory to its storage bag. Observe the caution note above when removing the capillary tubing.

5. Mark the gas tank in large letters "MT" to denote that it has been used to perform a gas check.
6. Dispose of the tank properly. The tank should never be refilled.

Assessing the Results

Provided there are no significant deviations from the pressure or temperature at which the original calibrations were performed, the displayed readings should fall within the following ranges of values:

Calibration Gas	Expected Result	Allowed Calibration Tolerance	Allowed Sample Tolerance	Overall Tolerance
Nitrous Oxide	25.0 ppm	±2.5 ppm	±0.5 ppm	±3.0 ppm
Sulfur Hexafluoride	1.0 ppm	±0.2 ppm	±0.02 ppm	±0.22 ppm

Call the factory if the actual readings recorded during this test are outside these limits. There are several reasons why this may occur:

1. Readings a few percent outside the overall tolerance should not be cause for alarm as these can often be accounted for by pressure or temperature deviation from the original calibration point. Of course, if atmospheric pressure is quite different, (usually lower) then this should be factored into the review.
2. Readings substantially lower may indicate an alteration in the internal optical alignment of the gas cell. Again, consult the factory for assistance.
3. Discordant readings are generally not caused by deterioration in the absolute signal levels within the instrument, such as may be caused by dirty optical components. Normally, this only affects the reading noise and not the actual instrument span.

Once the analysis is completed, secure the sampling accessory in a safe place and properly dispose of the gas cylinder. Do not dispose of the cylinder in a fire or incinerator. Tanks are not to be refilled. There may be some slight positive pressure remaining in the tank. If so, discharge the remaining contents until there is no further audible evidence of gas flow out of the tank, remembering always to have the tank nozzle pointed away from the face and body as it is released to atmospheric conditions.

Appendix F

PARTS and ACCESSORIES

The following parts and accessories are used with the 205B Series MIRAN SappHRe Portable Ambient Air Analyzer, Style A

Note: This product may be configured and supplied as an intrinsically safe device. Any disassembly of the product, or tampering within the analyzer enclosure will negate the intrinsically safe certification.

Summary of Parts used with this Product

Item	Part No.	Part Name
1	CR015AB	Air Sampling Hose Assembly
2	CR014GZ	Battery Pack
3	P0170QW	Serial Communication Cable, RS-232-C
4	CR013UJ	Shoulder Strap
5	107152-00	Power Supply/Dual Battery Charger
6	TR101TN	Charger/Chassis Interface Cable
7	TR101TK	Charger/Battery Pack Interface Cable
8	TR101RV	Pathlength Changing Tool
9	X0173QH	Battery Compartment Key
10	TR101ZU	Particulate Filters (2 recommended)
11	TR101PU	Zero Gas Filter (4 recommended)
12	TR101QX	Parallel Printer Cable
13	N0249XS	Power Cord, 115V, US (option)
14	TR101RW	Phillips Screwdriver
15	BK3538	Instruction Manual
16	8926	Power Cord, 220V, Europe (option)
17	107315-00	Power Cord, 220V, China (option)
18	07-010239	Cable, USB to Serial
19	07-010239-WI	Instructions, USB to Serial Cable

Summary of Accessories used with this Product

Item	Part No.	Part Name
20	CR014QC	Leak Detection and Sampling Wand
21	CR013XM	Transportation/Carrying Case
22	071-5707	Closed Loop Calibration System, 120V, 50/60 Hz
23	071-5752	Closed Loop Calibration System, 220V, 50/60 Hz
24	CR014LG	Field Performance Verification Kit
25	CR014MA	Gas Delivery System (replacement part for CR014LG)
26	CR014LN	Cylinder of N ₂ O and SF ₆ mixture in air (replacement part for CR014LG)
27	CR013VQ	Analog Output Cable
28	TR101TP	12V Charger Adapter Cable

Appendix F Parts and Accessories

Parts used with the 205B Series Analyzer, Style A

Air Sampling Hose Assembly
Part No. CR015AB



Battery Pack
Part No. CR014GZ



Serial Communication Cable (RS-232-C)
Part No. P0170QW



*Shoulder Strap
Part No. CR013UJ



Power Supply/Dual Battery Charger
Part No. 107152-00



Charger/Chassis Interface Cable
Part No. TR101TN



Charger/Battery Pack Interface Cable
Part No. TR101TK



Parts used with the 205B Series Analyzer, Style A

*Pathlength Changing Tool
Part No. TR101RV



*Battery Compartment Key
Part No. X0173QH



*Particulate Filter
Part No. TR101ZU (Individual Filters)



*Zero Gas Filter
Part No. TR101PU



Printer Cable
Part No. TR101QX



Power Cord, 115V
Part No. N0249XS



Phillips Screwdriver
Part No. TR101RW



Appendix F Parts and Accessories

Accessories used with the 205B Series Analyzer, Style A

Leak Detection and Sampling Wand
Part No. CR014QC



Transportation/Carrying Case
Part No. CR013XM



Closed Loop Calibration System
120V, 50/60 Hz Part No. 071-5707
220V, 50/60 Hz Part No. 071-5752



*Field Performance Verification Kit
Part No. CR014LG



Gas Delivery System
Part No. CR014MA

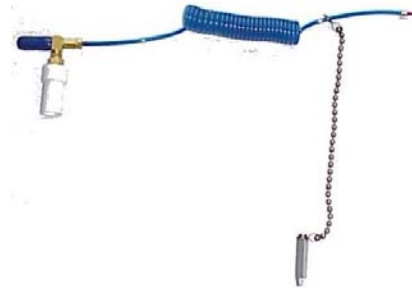

Cylinder to N2O and SF6 Mixture in Air
Part No. CR014LN



Analog Output Cable
Part No. CR013VQ



12V Charger Adapter Cable
Part No. TR101TP



Appendix G

USING HYPERTERMINAL with the MIRAN SAPPHIRE

The MIRAN SapphIRE is shipped with a Windows-based ThermoConnect program, which is the primary program, used to transfer data between the analyzer and a PC using an RS-232 connection. ThermoConnect does not work on some newer PCs running the Windows operating system. As an alternative, a 3rd party terminal program may be used instead of ThermoConnect. Any terminal program that is known to work under the operating system may be used to communicate with the analyzer. The SapphIRE supports communications with a 3rd party terminal using the TEXT-MANUAL transfer protocol.

Hyperterminal is the most widely available terminal program (it ships with Windows 95/98/ME, and Windows NT/2000). To start up Hyperterminal, choose Start... Programs... Accessories... HyperTerminal, then double-click on the Hypertrm.exe icon. If the Hyperterminal folder doesn't exist, it's because the communications package was not installed when Windows was installed. Hyperterminal may be installed by going into Windows Setup and selecting the Communications package to install it. Once running, type a name for the new connection (any name is acceptable), then click OK. Under the Phone Number window, set the Connect Using field to "Direct to Com X" (set X to whatever COM port the SapphIRE is connected to), then click OK:



Next, the port settings must be set on the properties screen. Hyperterminal must be set up with the proper settings to be able to talk to the analyzer:

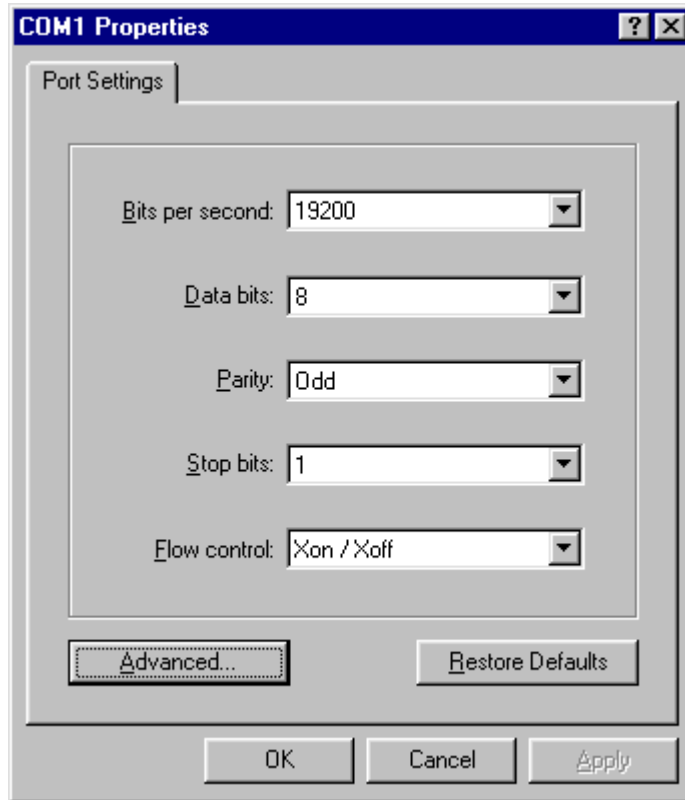

Note: The SapphIRe baud rate is user-selectable. While 19,200 baud is optimum, it may not be correct. The terminal program should be set to match the analyzer under 5=Report/Data, 3=Data transfer, 2=Change baud.

The analyzer must be configured for TEXT-MANUAL transfer protocol before using a 3rd party terminal application. From the main menu, this is done as follows:
5=Report/Data, 3=Data transfer, 1=Chnge mode, 2=Manual.

Once the SapphIRe is set up for TEXT-MANUAL and the terminal program is running, data may be sent from the analyzer to the PC. First, the terminal program should be set to write all incoming data to a file (capture the data). This is done in Hyperterminal by selecting the menu item Transfer... Capture Text, then setting the file name. Next, the transfer is originated at the SapphIRe by selecting 3=Send, then selecting the appropriate data from the SEND MENU: 1=Site, 2=Full setup, 3=Partial setup, 4=Library names.

To receive data on the SapphIRe from the PC, choose 4=Receive from the DATA TRANSFER menu on the SapphIRe then use the menu item Transfer... Send Text in Hyperterminal.

The type of data is included inside each of the text files, so the file type does not have to be selected before receiving data on the SapphIRe.

Appendix H

STANDARD LIBRARIES

Compound Name	Acronym	Library (see key)	HRL (ppm)	HRL (mg/m3)	Detection Limit (ppm)	Detection Limit (mg/m3)	Wavelength	Pathlength	Accuracy (+/-% of reading)
ACETALDEHYDE	ACETALD	XL	400	722	0.8	1.44	9.140	Long	10
ACETIC ACID	ACETCACD	SL	100	246	0.5	1.23	10.196	Long	15
ACETIC ACID	ACETCACD	SL	30	74	0.15	0.37	8.636	Long	20
ACETONE	ACETONE	SL	2000	4760	5	11.90	8.400	Short	5
ACETONE	ACETONE	SL	2000	4760	5	11.90	11.036	Long	5
ACETONITRILE	ACETONIT	XL	500	841	11	18.50	9.692	Long	10
ACETOPHENONE	ACETOPHE	XL	100	492	0.4	1.97	8.108	Long	25
ACETYLENE	ACETYLEN	XL	200	213	0.5	0.53	13.724	Long	10
ACRYLONITRILE	ACRYLONI	XL	50	109	0.6	1.30	10.470	Long	10
AMMONIA	NH3	SL	500	349	0.7	0.49	10.868	Long	20
AMMONIA	NH3	SL	500	349	0.7	0.49	10.484	Long	20
ANILINE	ANILINE	XL	50	191	0.5	1.91	8.045	Long	10
BENZALDEHYDE	BENZALD	XL	500	2174	0.9	3.91	12.188	Long	15
BENZENE	BENZENE	SL	200	640	2	6.40	9.796	Long	10
1,3-BUTADIENE	13BUTADI	SL	100	222	0.7	1.55	10.028	Long	10
1,3-BUTADIENE	13BUTADI	SL	50	111	0.35	0.78	11.060	Long	15
BUTANE	BUTANE	XL	2000	4764	5	11.91	10.436	Long	10
n-BUTYL ACETATE	BUTLACET	XL	300	1428	0.18	0.86	9.668	Long	15
n-BUTYL ALCOHOL	BUOH n-	XL	200	607	0.25	0.76	9.572	Long	15
t-BUTYL ALCOHOL	BUOH t-	XL	100	304	0.3	0.91	8.444	Long	15
BUTYL CELLOSOLVE	BUTLCELL	SL	100	484	0.25	1.21	9.008	Long	15
t-BUTYL METHYL ETHER	MTBE	XL	50	280	0.15	0.84	9.284	Long	10
CARBON DIOXIDE, absolute (a)	CO2ABS	SL	1000	1804	1	1.80	4.250	Short	15
CARBON DIOXIDE, absolute (a)	CO2ABS	SL	1000	1804	30	54.11	14.000	Long	25
CARBON DIOXIDE, differential (b)	CO2DIFF	SL	2000	3607	1.5	2.71	4.250	Short	15
CARBON DIOXIDE, differential (b)	CO2DIFF	SL	2000	3607	40	72.14	14.000	Long	25
CARBON DISULFIDE	CS2	XL	50	156	1	3.12	4.620	Long	15
CARBON MONOXIDE	CO	SL	250	287	0.9	1.03	4.620	Long	10
CARBON TETRACHLORIDE	CCL4-H	SL	100	630	1.2	7.565	12.660	Short	10
CARBON TETRACHLORIDE	CCL4-L	SL	5	32	0.05	0.32	12.660	Long	10
CELLOSOLVE	CELOSV-H	SL	500	1847	2.3	8.49	8.980	Short	10
CELLOSOLVE	CELOSV-L	SL	50	185	0.1	0.37	8.980	Long	10
CELLOSOLVE ACETATE	CLSLVAC	SL	200	1083	0.15	0.81	9.524	Long	25
CHLOROBENZENE	CLOROBEN	XL	150	692	0.4	1.85	9.332	Long	10
CHLOROBROMOMETHANE	CLBRMETH	XL	500	2651	0.4	2.12	8.324	Long	25
CHLOROFORM	CHCL3-H	SL	100	489	1.7	8.32	13.058	Short	15
CHLOROFORM	CHCL3-H	SL	100	489	0.5	2.45	8.372	Long	15

Compound Name	Acronym	Library (see key)	HRL (ppm)	HRL (mg/m3)	Detection Limit (ppm)	Detection Limit (mg/m3)	Wavelength	Pathlength	Accuracy (+/-% of reading)
CHLOROFORM	CHCL3-L	SL	10	49	0.07	0.34	13.058	Long	15
CHLOROFORM	CHCL3-L	SL	10	49	0.5	2.45	8.372	Long	15
m-CRESOL	MCRESOL	SL	10	44	0.4	1.77	8.756	Long	20
CUMENE	CUMENE	XL	100	493	1	4.93	13.256	Long	10
CYCLOHEXANE	CYCLHEX	SL	500	1724	6	20.69	11.156	Long	10
CYCLOHEXANE	CYCLHEX	SL	500	1724	6	20.69	8.108	Long	10
CYCLOPENTANE	CYCLPENT	XL	500	1437	6	17.25	11.252	Long	10
DESFLURANE	DESFLR-H	SL	100	689	0.7	4.82	8.588	Short	10
DESFLURANE	DESFLR-H	SL	100	689	0.7	4.82	9.092	Short	10
DESFLURANE	DESFLR-L	SL	10	69	0.04	0.28	8.588	Long	10
DESFLURANE	DESFLR-L	SL	10	69	0.04	0.28	9.092	Long	10
m-DICHLOROBENZENE	MDICLBNZ	XL	150	904	0.35	2.11	12.836	Long	15
o-DICHLOROBENZENE	ODICLBNZ	XL	100	602	0.6	3.61	8.992	Long	25
p-DICHLOROBENZENE	PDICLBNZ	XL	150	904	0.25	1.51	9.284	Long	15
1,1-DICHLOROETHANE	11DICLOR	XL	200	811	0.4	1.62	9.548	Long	20
1,2-DICHLOROETHYLENE	12DICLOR	XL	500	1986	0.6	2.38	11.204	Long	15
DICHLOROETHYLETHER	2CLETH	XL	50	293	0.12	0.70	8.970	Long	25
DIETHYLAMINE	DIETHLAM	XL	50	150	0.35	1.05	8.900	Long	10
DIMETHYLACETAMIDE	DMAC	XL	30	107	0.4	1.43	8.588	Long	15
DIMETHYLAMINE	DIMETHAM	XL	50	92	0.6	1.11	8.828	Long	10
N,N-DIMETHYLFORMAMIDE	DMF	XL	20	60	0.2	0.60	9.404	Long	10
DIOXANE	DIOXANE	XL	100	361	0.08	0.29	8.996	Long	15
ENFLURANE	ENFLRN-H	SL	100	756	0.6	4.54	8.900	Short	10
ENFLURANE	ENFLRN-H	SL	100	756	0.2	1.51	12.116	Long	10
ENFLURANE	ENFLRN-L	SL	10	76	0.03	0.23	8.900	Long	10
ENFLURANE	ENFLRN-L	SL	10	76	0.2	1.51	12.116	Long	10
ETHANE	ETHANE	XL	1000	1232	0.3	0.37	3.333	Long	20
ETHANOLAMINE	ETHNOLAM	XL	50	125	0.7	1.75	8.900	Long	20
ETHYL ACETATE	ETHYLACT	XL	500	1805	1.1	3.97	8.290	Short	10
ETHYL ALCOHOL	ETOH	XL	2000	3776	5	9.44	9.596	Short	10
ETHYL BENZENE	ETHYLBZ	XL	200	870	1.2	5.22	13.520	Long	15
ETHYL CHLORIDE	ETHLCLOR	XL	1500	3966	1	2.64	10.388	Long	10
ETHYL ETHER	ETHYLETH	XL	500	1519	1.8	5.47	8.972	Long	10
ETHYL LACTATE	ETHLAC	SL	100	484	0.08	0.39	8.348	Long	15
ETHYLENE	ETHYLENE	XL	100	115	0.4	0.46	10.628	Long	10
ETHYLENE DICHLORIDE	ETHDICHL	XL	100	406	0.7	2.84	8.300	Long	10
ETHYLENE OXIDE	ETO	SL	100	181	0.35	0.63	11.652	Long	10
ETHYLENE OXIDE	ETO	SL	100	181	0.6	1.08	3.333	Long	10
FORMALDEHYDE	FORMALD	SL	10	12	0.5	0.14	3.573	Long	10
FORMIC ACID	FORMIC	XL	30	57	0.12	0.23	9.165	Long	20

Compound Name	Acronym	Library (see key)	HRL (ppm)	HRL (mg/m3)	Detection Limit (ppm)	Detection Limit (mg/m3)	Wavelength	Pathlength	Accuracy (+/-% of reading)
GEN HALOCARBONS (Chloroform)	GENHAL-H	SL	100	489	1.7	0.34	13.058	Short	15
GEN HALOCARBONS (Chloroform)	GENHAL-L	SL	10	49	0.07	8.32	13.058	Long	15
GEN HYDROCARBONS (Hexane)	THCHEX	SL	500	1766	0.25	1.02	3.333	Long	25
GEN HYDROCARBONS (Methane)	THCMETH	SL	20	13	1.5	0.99	3.333	Long	15
HALOTHANE	HALTHN-H	SL	100	809	1.5	12.13	12.372	Short	10
HALOTHANE	HALTHN-H	SL	100	809	0.09	0.73	8.972	Long	15
HALOTHANE	HALTHN-L	SL	10	81	0.25	2.02	12.372	Long	10
HALOTHANE	HALTHN-L	SL	10	81	0.09	0.73	8.972	Long	15
HEPTANE	HEPTANE	XL	1000	4107	10	41.07	10.772	Long	10
n-HEXANE	HEXANE	XL	500	1766	0.25	0.88	3.333	Long	25
HYDRAZINE	HYDRAZIN	XL	50	66	0.8	1.05	10.844	Long	10
ISOBUTANE	ISOBUTAN	XL	250	595	2.5	5.95	8.684	Long	10
ISOFLURANE	ISOFLR-H	SL	100	756	0.7	5.29	8.804	Short	10
ISOFLURANE	ISOFLR-H	SL	100	756	0.5	3.78	11.372	Long	10
ISOFLURANE	ISOFLR-L	SL	10	76	0.04	0.30	8.804	Long	10
ISOFLURANE	ISOFLR-L	SL	10	76	0.5	3.78	11.372	Long	10
ISOPROPYL ALCOHOL	IPA-H	SL	1000	2463	10	24.63	10.586	Short	10
ISOPROPYL ALCOHOL	IPA-H	SL	1000	2463	4	9.85	12.303	Long	10
ISOPROPYL ALCOHOL	IPA-L	SL	100	246	0.5	1.23	10.586	Long	10
ISOPROPYL ALCOHOL	IPA-L	SL	100	246	0.3	0.739	8.852	Long	10
ISOPROPYL ETHER	IPETHER	XL	1000	4187	3	12.56	9.044	Short	10
METHANE	METHANE	SL	100	66	1.5	0.99	3.333	Long	15
METHYL ACETATE	METHACET	SL	500	1518	1.3	3.95	8.204	Short	10
METHYL ACETATE	METHACET	SL	500	1518	6	18.21	9.644	Short	10
METHYL ACRYLATE	METHACRY	XL	20	71	0.07	0.25	8.492	Long	15
METHYL ALCOHOL	MEOH	XL	500	656	0.7	0.92	10.220	Long	15
METHYL CELLOSOLVE	MCELLO	SL	100	312	0.15	0.47	9.500	Long	15
METHYL CELLOSOLVE ACETATE	MCELOA	SL	100	484	0.14	0.68	8.924	Long	15
METHYL CELLOSOLVE ACETATE	MCELOA	SL	100	484	0.15	0.73	9.524	Long	15
METHYL CHLORIDE	MECL	XL	200	414	1.7	3.52	13.508	Long	10
METHYL CHLOROFORM	111TRICL	XL	500	2734	0.15	0.82	9.380	Long	25
METHYL ETHYL KETONE	MEK	SL	1000	2955	7	20.69	8.692	Short	15
METHYL ETHYL KETONE	MEK	SL	1000	2955	1.6	4.73	10.676	Long	20
METHYL ISOBUTYL KETONE	MIBK	XL	100	410	0.35	1.44	8.708	Long	10
METHYL METHACRYLATE	METHMACR	SL	250	1026	0.4	1.64	10.748	Long	10
METHYL METHACRYLATE	METHMACR	SL	250	1026	0.7	2.87	12.284	Long	15
METHYLACETYLENE	MACETYLN	XL	1000	1643	1.2	1.97	8.156	Long	10
METHYLAMINE	METHAMIN	XL	50	64	0.6	0.76	12.908	Long	10
METHYLENE CHLORIDE	MECL2	SL	200	696	4	13.92	13.316	Short	10
NITROGEN TRIFLUORIDE	NF3	XL	50	145	0.04	0.12	11.108	Long	10

Compound Name	Acronym	Library (see key)	HRL (ppm)	HRL (mg/m3)	Detection Limit (ppm)	Detection Limit (mg/m3)	Wavelength	Pathlength	Accuracy (+/-% of reading)
NITROUS OXIDE	N2O	SL	100	180	0.04	0.072	4.500	Long	10
OCTANE	OCTANE-H	XL	1000	4681	5	23.41	3.333	Short	25
OCTANE	OCTANE-L	XL	100	468	0.35	1.64	3.333	Long	25
PENTANE	PENTANE	XL	2000	5913	6	17.74	11.060	Long	10
PERCHLOROETHYLENE	PERC-H	SL	500	3398	2	13.59	11.010	Short	10
PERCHLOROETHYLENE	PERC-L	SL	50	340	0.09	0.612	11.010	Long	20
PERCHLOROETHYLENE	PERC-L	SL	50	340	0.4	2.72	12.884	Long	10
PGMEA	PGMEA	XL	50	271	0.07	0.38	8.204	Long	20
PHOSGENE	PHOSGENE	XL	5	20	0.05	0.20	11.876	Long	10
PROPANE	PROPANE	XL	2000	3614	20	36.14	13.436	Long	10
n-PROPANOL	PROPOH	XL	500	1231	0.6	1.48	10.388	Long	10
PROPYLENE OXIDE	PROPOXID	XL	200	476	0.7	1.67	12.044	Long	15
PYRIDINE	PYRIDINE	XL	100	324	1.5	4.86	9.812	Long	10
TRICHLOROMONOFUOROMETHANE	R11	XL	1000	5630	1	5.63	10.796	Long	15
TRICHLOROTRIFLUOROETHANE	R113	SL	1000	7679	1.7	13.05	11.108	Short	15
TRICHLOROTRIFLUOROETHANE	R113	SL	1000	7679	2.5	19.20	9.716	Short	10
1,2-DICHLOROTETRAFLUROETHANE	R114	SL	1000	7005	2	14.01	9.668	Short	10
1,2-DICHLOROTETRAFLUROETHANE	R114	SL	1000	7005	1.5	10.51	11.900	Short	10
DICHLORODIFLUOROMETHANE	R12	SL	1000	4955	1.4	6.94	10.940	Short	15
DICHLORODIFLUOROMETHANE	R12	SL	1000	4955	1.5	7.43	9.212	Short	15
DICHLOROTRIFLUOROETHANE	R123-H	SL	200	1253	1.3	8.15	8.548	Short	15
DICHLOROTRIFLUOROETHANE	R123-H	SL	200	1253	1.5	9.40	13.124	Long	15
DICHLOROTRIFLUOROETHANE	R123-L	SL	10	63	0.07	0.44	8.548	Long	15
DICHLOROTRIFLUOROETHANE	R123-L	SL	10	63	0.09	0.56	8.876	Long	15
1-CHLORO-1,1,2,2-TETRAFLUROETHANE	R124-H	SL	500	2797	1.4	7.83	8.468	Short	15
1-CHLORO-1,1,2,2-TETRAFLUROETHANE	R124-H	SL	500	2797	3	16.78	11.396	Short	15
1-CHLORO-1,1,2,2-TETRAFLUROETHANE	R124-L	SL	100	559	0.05	0.28	8.468	Long	15
1-CHLORO-1,1,2,2-TETRAFLUROETHANE	R124-L	SL	100	559	0.2	1.12	11.396	Long	15
1,1,1,2-TETRAFLUROETHANE	R134A	XL	200	836	0.17	0.71	9.236	Long	10
BROMOTRIFLUOROMETHANE	R13B1	XL	1000	6102	1	6.10	9.404	Short	15
1,1-DICHLORO-1-FLUROETHANE	R141B	XL	200	959	0.17	0.81	10.892	Long	15
1,1,1-TRIFLUOROETHANE	R143a	XL	25	87	0.05	0.17	8.312	Long	15
1,1-DIFLUOROETHANE	R152a	XL	25	68	0.06	0.16	8.972	Long	15
DICHLOROFLUROETHANE	R21	SL	1000	4218	2	8.44	9.452	Short	10
DICHLOROFLUROETHANE	R21	SL	1000	4218	1.5	6.33	12.524	Short	10
CHLORODIFLUOROMETHANE	R22	SL	1000	3544	1	3.54	9.140	Short	10
CHLORODIFLUOROMETHANE	R22	SL	1000	3544	2.5	8.86	12.452	Short	10
DICHLOROPENTAFLUROPROPANE	R225	XL	100	404	0.1	0.40	9.188	Long	10
SEVOFLURANE	SEVFLN-H	SL	100	820	0.7	5.74	8.308	Short	10
SEVOFLURANE	SEVFLN-L	SL	10	82	0.03	0.25	8.308	Long	10

Compound Name	Acronym	Library (see key)	HRL (ppm)	HRL (mg/m3)	Detection Limit (ppm)	Detection Limit (mg/m3)	Wavelength	Pathlength	Accuracy (+/-% of reading)
STYRENE	STYRNE-H	SL	1000	4268	15	64.02	11.076	Short	15
STYRENE	STYRNE-L	SL	200	854	0.6	2.56	11.076	Long	15
STYRENE	STYRNE-L	SL	200	854	0.7	2.99	12.980	Long	15
SULFUR DIOXIDE	SO2	SL	30	79	1.2	3.15	8.780	Long	10
SULFUR HEXAFLUORIDE (c)	SF6	SL	4	24	0.01	0.06	10.708	Long	1(10). 4(20)*
SULFURYL FLUORIDE	SULFRYLF	XL	30	125	0.1	0.418	11.550	Long	10
TETRAHYDROFURAN	THF	XL	500	1478	0.5	1.48	8.660	Long	10
TOLUENE	TOLUEN-H	SL	1000	3776	18	67.97	13.836	Short	10
TOLUENE	TOLUEN-H	SL	1000	3776	4	15.10	9.404	Long	10
TOLUENE	TOLUEN-L	SL	200	755	1	3.78	13.836	Long	15
1.1.2-TRICHLOROETHANE	3CLETHAN	XL	30	164	0.25	1.37	13.580	Long	10
1.1.2.2-TETRACHLOROETHANE	4CLETHAN	XL	20	138	0.25	1.72	12.452	Long	10
TRICHLOROETHYLENE	TCE	SL	1000	5384	4	21.54	10.764	Short	10
TRICHLOROETHYLENE	TCE	SL	1000	5384	4	21.54	11.876	Short	15
VINYL ACETATE	VINLACET	XL	10	35	0.04	0.14	8.348	Long	15
VINYL CHLORIDE	VINLCLOR	SL	20	51	0.6	1.545	10.724	Long	10
VINYL CHLORIDE	VINLCLOR	SL	20	51	1.6	4.10	9.788	Long	10
VINYLDIENE CHLORIDE	VINLIDCL	XL	20	79	0.2	0.79	12.692	Long	10
XYLENE	XYLENE-H	SL	2000	8702	30	130.53	13.132	Short	10
XYLENE	XYLENE-H	SL	2000	8702	7	30.46	12.600	Long	15
XYLENE	XYLENE-L	SL	200	870	1.3	5.66	13.132	Long	15

Note: The SapphIRe-SL contains those compounds with and “SL” in the library column. The SapphIRe-XL contains all compounds in this list.

Accuracy is defined as +/- the average value displayed from five times the detection limit to the full scale reading (e.g.. Acetaldehyde from 4.0 to 400 ppm: accuracy is +/- 10% of reading.

Detection limit is the point at which the analyzer will consistently and repeatably detect the presence of the subject gas.

- (a) Carbon dioxide (absolute) refers to the measurement of CO₂ where the SapphIRe analyzer has been purged with CO₂ free air such as nitrogen. Since CO₂ is present in the air at levels of approximately 350 ppm and since the zero gas filter cannot scrub the CO₂, the only way to generate a true level of CO₂ is to flush or zero the analyzer with CO₂ free air. The factory calibration for CO₂ was zeroed with nitrogen. Likewise, when using the CO₂ (absolute) calibration, the analyzer must be zeroed with CO₂ free air.
- (b) Carbon dioxide (differential) refers to a measurement of CO₂ when the SapphIRe analyzer is zeroed in a level of normal ambient air (350 ppm of CO₂). When this calibration is used, a background level of CO₂ must be added at the zero area to the analyzer’s display value.
- (c) 0 to 1 ppm (±10%); 1 to 4 ppm (±20%)

INDEX

A

Absorption Peaks	13-9
Accessories, Parts and.....	F-1
Alarm Clear.....	4-2
Alarm Settings for an Application	7-24
Alarms, Configuring	7-11
Alpha Characters, Entering	4-3
Analog Output.....	4-17
Analysis.....	7-7
Analysis, To Begin.....	5-4
Analysis Preferences	7-15
Analysis Setup	7-8
Application View and Edit.....	7-25

B

Batch Sample, Configuring.....	7-17
Battery Conditioning.....	3-7
Battery Indicator Calibration	3-6
Battery Pack Maintenance	10-1
Battery Status	4-2, 7-4
Baud Rate, Changing	9-3
Beer-Lambert Law	13-16

C

Cable Identification.....	3-2
Calibration.....	7-3, C-1
Charger/Power Supply	3-5
Choose Application.....	7-21
Clock	7-6
Compensations, Specifying Analysis.....	7-13
Configuration	7-1
Connections, Output	3-8
Contrast Adjustment	4-2
Control Menu	4-2
Controls.....	4-1

D

Data/Report Transfer	9-1
Data Transfer	9-3

Index

Display4-1

E

Electromagnetic Energy13-1

Error Fault Messages5-7

Error Screens.....4-13

F

Filter Maintenance10-1

Firmware Update11-1

Flag Screens5-8

Flowchart, Application View and Edit 7-25

G

Gas, Change6-1

Gas Unit7-5

H

Humidity Compensation7-35

Humidity Compensation TableD-1

Hyperterminal9-5, G-1

I

Identification3-3

Information Screens4-12

Intrinsic SafetyB-1

K

Keys, Function of.....4-1

L

Libraries, StandardH-1

Location Name5-5

Locations, Configuring7-20

Log5-5

Log Capacity, Configuring7-19

Logging Characteristics, Changing.....7-8

M

Maintenance	10-1
Matrix Parameters	7-40
Memory, Clearing	9-5
Menu Selections, Making	4-3

O

Operation.....	4-1
Optics, Care of	10-2

P

Particulate Filter Replacement	10-1
Parts and Accessories.....	F-1
Passcode Access.....	4-2
Passcode, Configuring the	7-19
Pathlength, Changing.....	4-16
Performance Verification.....	12-1, E-1
Power Supply/Charger	3-5
Preferences	7-3
Pressure Compensation.....	7-32
Print Menu	9-2
Pump, Turning On or Off.....	4-2
Purging Gas Cell.....	5-1

Q

Qualitative Analysis.....	13-7
Quantitative Analysis.....	13-15

R

Reference Compensation	7-33
Report Formatting, Custom	14-1
Report Output, Configuring	7-20
Report/Data Transfer	9-1

S

Scan Procedure.....	C-1
Search Feature.....	4-11
Setup	7-1
Shoulder Strap, Adjusting.....	3-4

Index

Site Info.....	8-1
Site Selection for Report/Data Transfer.....	9-1
Specifications.....	2-1
Startup Procedure.....	4-4
STEL Time Setting for an Application.....	7-24

T

Temperature Compensation	7-32
Tutorial, Infrared Spectroscopy	13-1

U

Unit Selection for an Application	7-23
User Settings for an Application.....	7-22

V

View Enable, Configuring	7-18
--------------------------------	------

W

Wand and Filters, Assembling.....	3-4
Warranty	A-1
Waves, Properties of	13-3

Z

Zero Gas Filter Storage and Replacement	10-1
Zero Warning, Configuring	7-17
Zeroing the Analyzer	5-1, 5-5